



# **TCP300V**

## **Series**

# **Point Card System Operation Manual**



[First Edition]

Issued : July, 2004

# Introduction

Thank you for purchasing Star's TCP300V series card reader/writer.

Carefully read this "Point Card System" manual prior to using the device, and always keep it handy for reference while using this product. The information contained in this document will help you use the system correctly. Refer to the "User's Guide" that accompanied your new reader/writer for details on the device.

**The "User's Guide" describes important safety information and should be read carefully.**

It is recommended that after you finish reading this manual, store it safely with the "User's Guide" where you can easily refer to it.

## Precautions

1. Unauthorized copying of any or all of the contents in this manual is strictly prohibited.
2. The contents of this document may change without prior notice because of functional improvements.
3. Every effort was made to ensure the completeness and correctness of the information contained herein. In the event that there are any areas of this manual which are difficult to understand, or that are incorrect, contact us or our sales outlets.

 This printer is considered a Class A Information Technology equipment according to the standards as prescribed by the Voluntary Control Council for Interference by Information Technology Equipment (VCCI). This printer may cause electrical wave interference if used in a home environment. In such cases users should take the appropriate precautions.

# TABLE OF CONTENTS

## *Chapter 1 Before Use*

<input type="checkbox"/> <b>Check the accessories</b> .....	<b>1</b>
<input type="checkbox"/> <b>Features</b> .....	<b>1</b>
<input type="checkbox"/> <b>Names of Parts and Functions</b> .....	<b>2</b>
Front side.....	2
Back side.....	3
Tenkey.....	4
• Allocation of Each Key.....	5
<input type="checkbox"/> <b>Installing and Removing the Compact Flash Card</b> .....	<b>6</b>
• Installing a compact flash card.....	6
• Removing a compact flash card.....	6
<input type="checkbox"/> <b>Specifications</b> .....	<b>7</b>
• Card Specifications.....	7
• Compatible modems.....	7
• Limits on the number of digits and values that can be input.....	7

## *Chapter 2 Operating the Reader/Writer*

<input type="checkbox"/> <b>Operating procedures</b> .....	<b>8</b>
<input type="checkbox"/> <b>Initial Operations and Settings</b> .....	<b>9</b>
• Display immediately after turning the power on.....	9
• Communicating with an office computer.....	9
<input type="checkbox"/> <b>Basic Operations</b> .....	<b>11</b>
• Adding points.....	11
• When the multiplier of the points is not changed.....	11
• When change the point multiplier.....	12
• Exchanging points.....	14
• Subtracting points by returning products.....	14
• When the multiplier of the points is not changed.....	14
• When change the point multiplier.....	15
• Inputting a password.....	16

• Correcting previous point operations .....	17
• Re-writing a member card .....	18
• Issuing a new member card .....	18
• Registering a member .....	19
• Re-issuing a member card .....	20
• Exchanging a member card .....	22
• Invalidating a member card .....	23
• Cleaning.....	24
• Automatic communication.....	25
• Manual transmission.....	25
• Delete history .....	26
• Delete all history.....	27
<input type="checkbox"/> <b>Welcome point only.....</b>	<b>28</b>
• Adding points.....	28
• Delete all history.....	29
• Cleaning.....	29
• Adjusting the display .....	29
<input type="checkbox"/> <b>Check Operations.....</b>	<b>30</b>
• Checking the current settings.....	30
• Checking the compact flash card.....	33
• Checking the journal data.....	33
<input type="checkbox"/> <b>Settings and Making Setting Changes .....</b>	<b>36</b>
• Setting the date and time .....	36
• Setting messages .....	37
• Changing settings relating to points .....	38
• Changing the password.....	40
• Setting the system .....	41
• How to make settings without using a system setting card .....	41
<b>If [Normal] is selected .....</b>	<b>42</b>
• How to set using the system setting cards .....	49
<b>If [Welcome point only] is selected .....</b>	<b>51</b>
• Adjusting the display .....	53

# Chapter 3 Troubleshooting and Maintenance

- **Cleaning** ..... **54**
  - Frequency of cleaning ..... 54
  - Cleaning procedures in terminal mode ..... 54
  - Cleaning procedures in stand-alone mode ..... 54
- **When trouble occurs** ..... **56**
  - Display messages ..... 56
  - Trouble when turning on the power ..... 58
  - Trouble when operating ..... 59

## Meaning of Symbols Used in This Manual

The information symbols used in this manual provide additional and precautionary information.



This indicates areas where you should use caution when using the device.



This indicates areas where you should know about the device for use.



This indicates page numbers of related information or pages for reference.

# ■ Chapter 1 Before Use

## Check the accessories

Check that all of the following items have been included in the package.

If any item was not included contact the sales outlet.

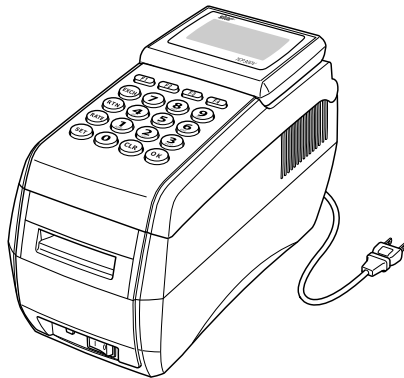

TCP300V 1 unit



Cleaning fluid 1 bottle

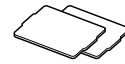

Cleaning cards 2 cards

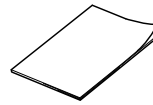

User's manual 1 booklet

## Features

### High-speed rewriting (Approximately 3 seconds)

The industry's fastest processing speed. Opaque type rewrites in 3 seconds.

### Large external memory (Optional)

Has slot for commonly used compact flash. This makes it easy to save data and read using a PC. 256 MB cards can be used; Saves hundreds of thousands to millions of transaction data.

### Easy-to-read display

Large display can display up to six lines of 20 characters (single byte characters). Also includes a tilting mechanism to adjust to any angle for easier viewing.

### Chinese character conversion input

Includes a function for converting Chinese characters using a tenkey system. Enables customer name input and messaging to promote sales.

### Multi-system function member

Issues, reissues or invalidates card. Enables setting fixed-term points and applies ECO-points.

Points can be converted or their multipliers changed.

Member card data has functions for preventing falsification of remaining points.

Terminal units can be provided with individual numbers. This makes it possible to organize point increases/decreases and correction logs for each device, and to get transaction data of each device, such as sales and purchase records.

Transaction data can be collected on a host via communications.

Can be set as a dedicated 'welcome point' device.

# Names of Parts and Functions

## Front side

### ● Display

Shows the input characters and content of the business.

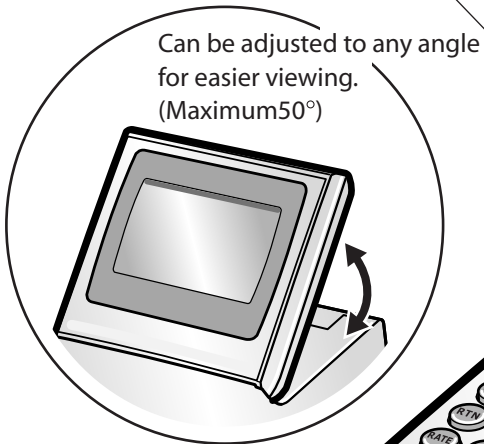

### ● Tenkey

➔ See page 4

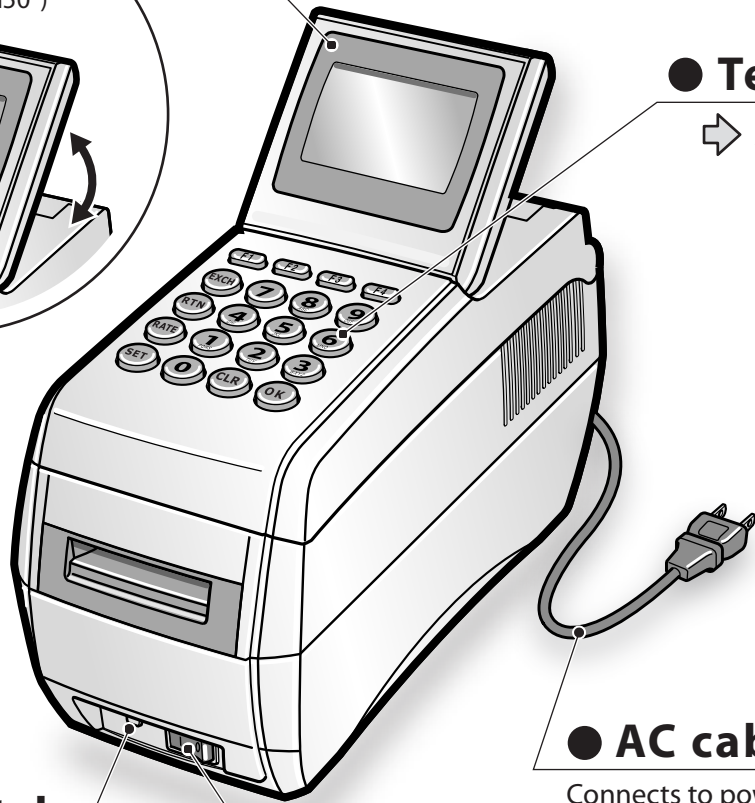

### ● Cleaning switch

Cleans the device.

➔ See page 54

### ● AC cable

Connects to power source.

### ● Power switch

This turns the power to the reader/writer on and off.

**Back side**

● **Slot cover**

Open the slot cover to install the compact flash card.

➔ See page 6

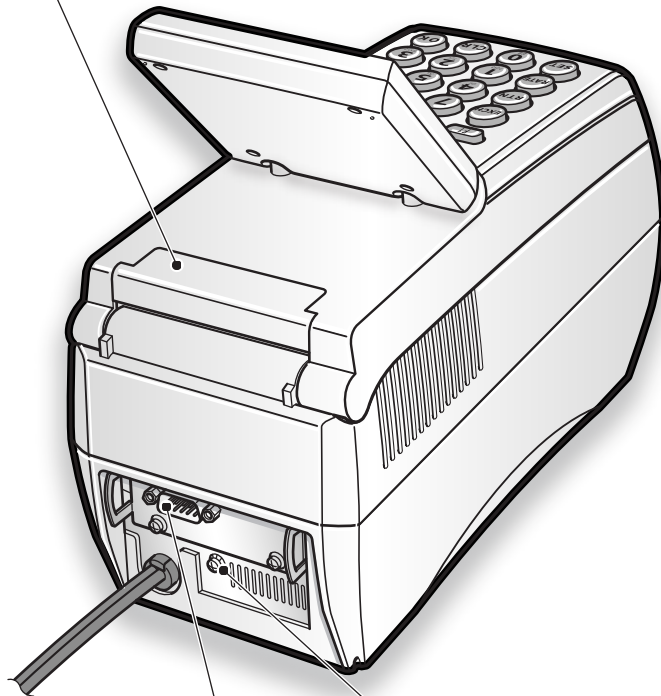

● **Interface connector**

Cable connects to host computer and modem.

● **Grounding screw**

This connects to the grounding wire.



# Names of Parts and Functions

## Tenkey

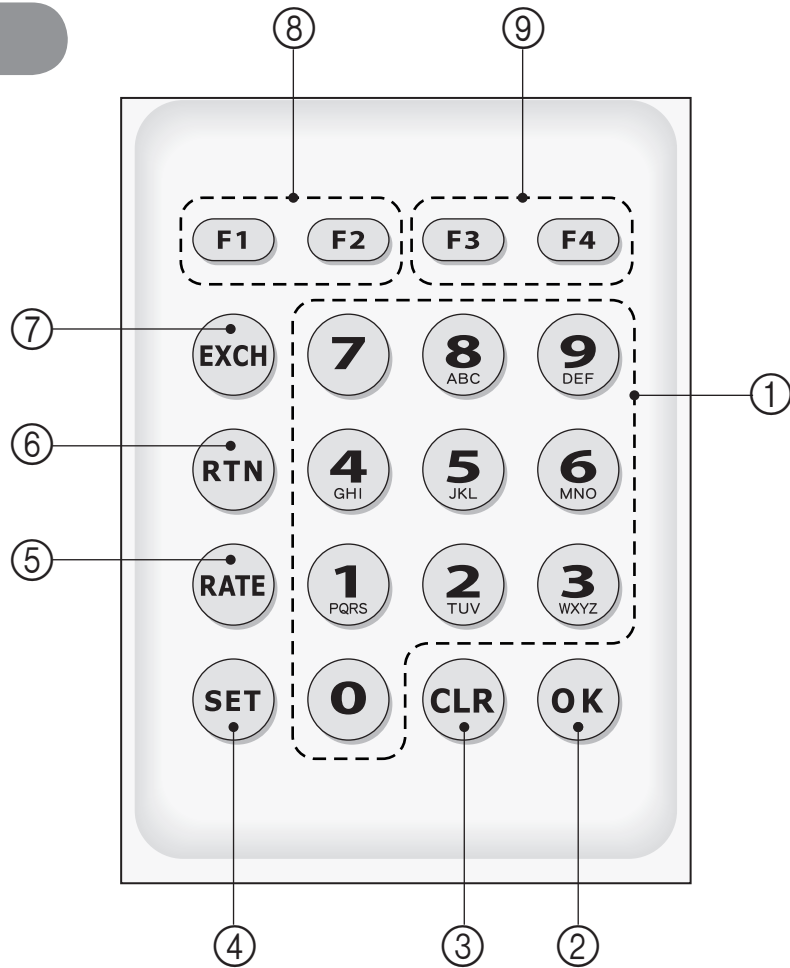

	Keys	Name and Function		Keys	Name and Function
①	 	<b>Numerical keys</b> Used to input amounts (of money), points and characters. (➡ See page 5)	⑥		<b>RTN key</b> Used to subtract points when a product is returned.
②		<b>OK key</b> Used to confirm the input. Used to select Y in the (Y/N) confirmation display.	⑦		<b>EXCH key</b> Used to convert accumulated points for products or gift certificates.
③		<b>CLR key</b> Used to delete input information, terminate processing, initialize the system and return to the previous menu. Used to select N in the (Y/N) confirmation display.	⑧	 	<b>(F1 and F2) Function keys</b> Used to display the list of functions. The F1 key is used to switch the character input modes.
④		<b>SET key</b> Used to confirm system settings.	⑨	 	<b>(F3 and F4) Function keys</b> Used to select functions. The F3 key is used to temporarily confirm or select previous candidate character when inputting characters; and the F4 key is used to convert characters or show the next candidate character when inputting characters.
⑤		<b>RATE key</b> Used to change the multiplier of the points.			

## Names of Parts and Functions

### • Allocation of Each Key when Inputting Characters

The characters change in the following order when each key is pressed.

After switching to the "symbol" mode by displaying the symbols using the F1 key, switch the symbols using the F4 key after pressing any tenkey.

The display does not return to the top symbol with F4 after the last symbol is displayed.

Keys	English	Number
7		7
8 ABC	A ⇒ B ⇒ C ⇒ a ⇒ b ⇒ c	8
9 DEF	D ⇒ E ⇒ F ⇒ d ⇒ e ⇒ f	9
4 GHI	G ⇒ H ⇒ I ⇒ g ⇒ h ⇒ i	4
5 JKL	J ⇒ K ⇒ L ⇒ j ⇒ k ⇒ l	5
6 MNO	M ⇒ N ⇒ O ⇒ m ⇒ n ⇒ o	6
1 PQRS	P ⇒ Q ⇒ R ⇒ S ⇒ p ⇒ q ⇒ r ⇒ s	1
2 TUV	T ⇒ U ⇒ V ⇒ t ⇒ u ⇒ v	2
3 WXYZ	W ⇒ X ⇒ Y ⇒ Z ⇒ w ⇒ x ⇒ y ⇒ z	3
0		0

# Installing and Removing the Compact Flash Card

Using a compact flash card enables you to save customer data and to load it onto your PC.

**i** Compact flash cards are not accessory items.

## • Installing a compact flash card

- ① Make sure that the power switch is turned off.
- ② Remove the slot cover.

**i** It can be removed easily by putting your finger under it and lifting upward.

- ③ Gently insert a compact flash card in the direction indicated in the drawing. Push in firmly. The eject button will protrude if the compact flash card is fully inserted.

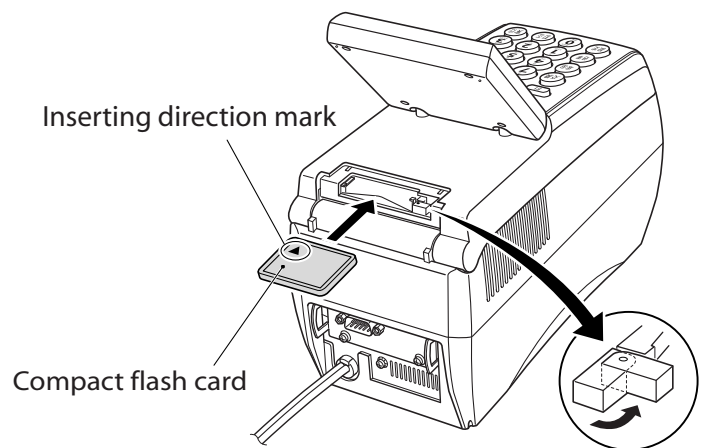
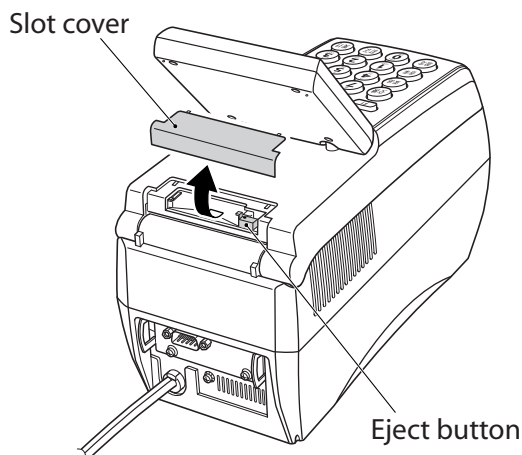

If the compact flash card does not easily fit into the slot, do not force it in. Check the direction of the card and try again.

- ④ Once the compact flash card is correctly inserted, fold over the eject button.
- ⑤ Replace the slot cover.

## • Removing a compact flash card

- ① Make sure that the power switch is turned off.
- ② Remove the slot cover.  
It can be removed easily by putting your finger under it and lifting upward.
- ③ Press the card slot eject button.  
The compact flash card will come out from the connector.  
Grip the edge of the compact flash card and pull it from the slot.
- ④ Replace the slot cover.

### **!** Precautions

Always turn off the power before installing or removing the compact flash card.  
If you remove it incorrectly, it is possible that the system will not operate correctly.



# Chapter 2 Operating the Reader/Writer

## Operating procedures

This section describes the flow of operating procedures and provides reference page numbers.  
Normal operations

### Normal Operations

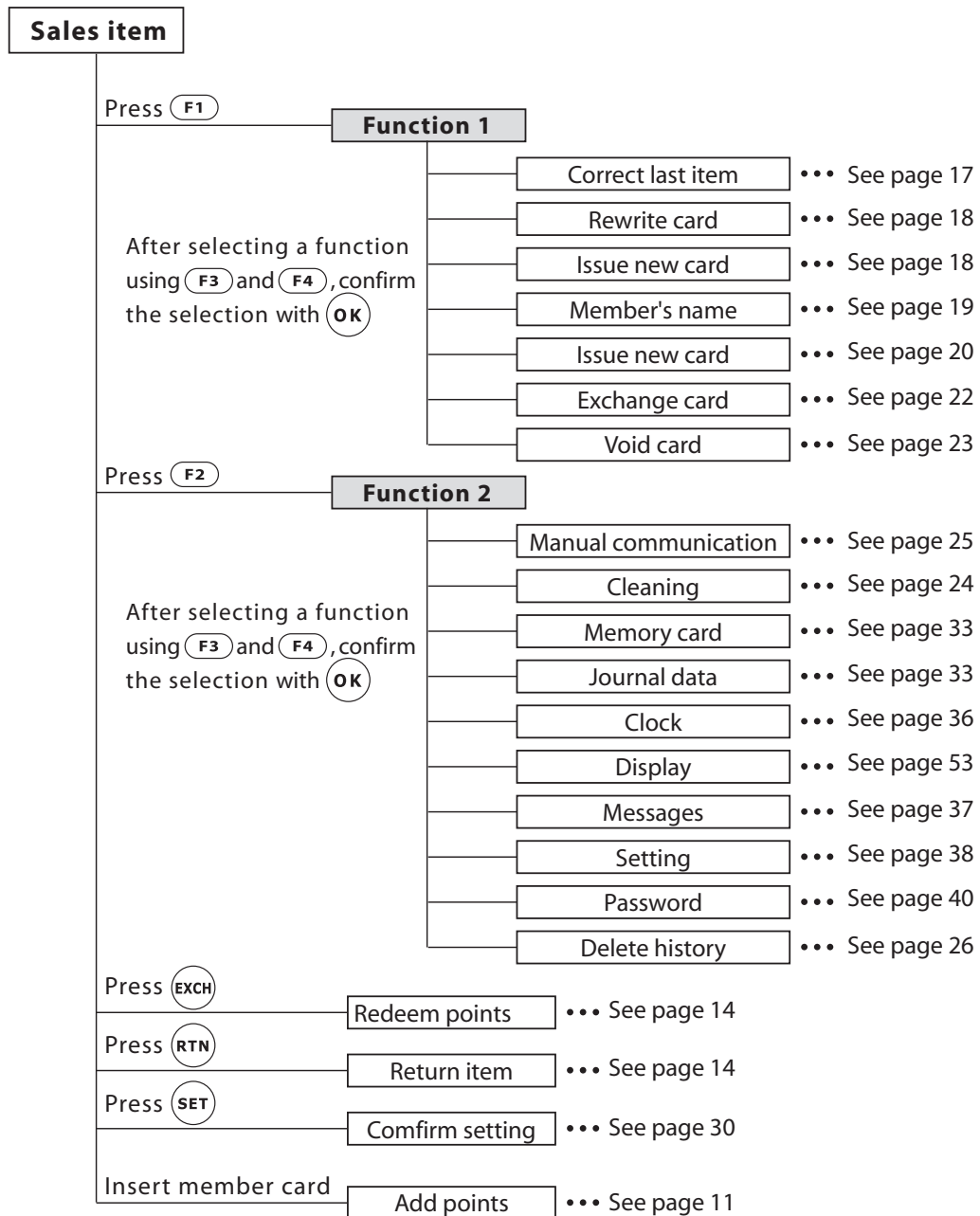

### For welcome points

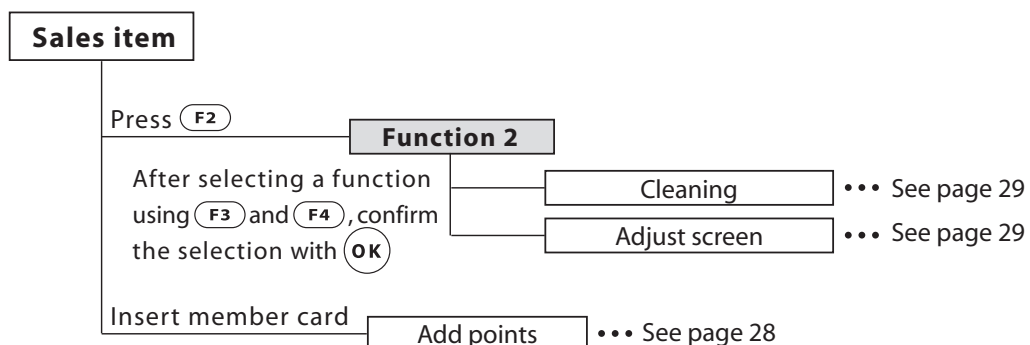

# Initial Operations and Settings

## • Display immediately after turning the power on

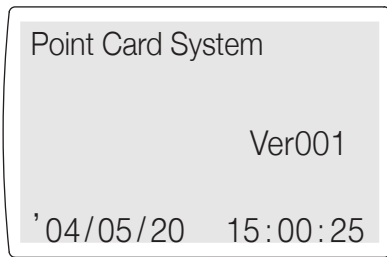

The system version number is displayed.

Check this version information when contacting or consulting with your dealer.

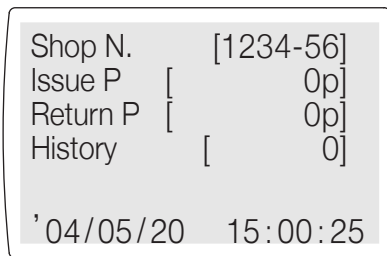

The machine enters an **<idling state>**.

In the <idling state>, the first line shows the Shop No. and machine control number; The second line shows the number of points issued through Sales items; The third line shows the total number of points that were recovered by the return of products, and the fourth line shows the history information (the number of cases).

When the system is idling, each of the functions of **EXCH**, **RTN**, and **SET** can be executed. **F1** and **F2** call up function lists, and **F3** and **F4** are used to select from those lists. When selected, **OK** executes the function that was selected.

## • Communicating with an office computer



A confirmation using manual communication is requested if automatic communication time with the office computer is exceeded when the power to the system is turned on.

(This is valid only when the communication function is enabled.)

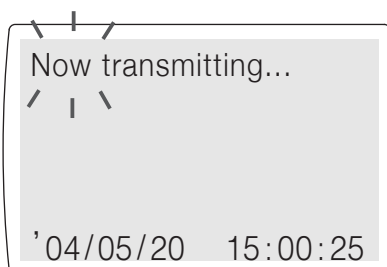

When [YES] is selected, the system begins communicating with the office computer. It uploads history information and downloads settings.

## Initial Operations and Settings

Retry?  [YES]  [NO]

'04/05/20 15:00:25

Retry confirmation is requested when communications are interrupted because of busy lines when communicating with the computer. To retry, select [YES].

Shop N. [1234-56]  
Issue P [ 0p]  
Return P [ 0p]  
History [ 0]

'04/05/20 15:00:25

The system idles again when communications end normally.

The series of operations can be performed relating to Sales items by inserted a member card. (⇒ See page 11)

**i** Automatic communication is not performed while the system is executing a function. It occurs only when the system is idling.

### Manual communication should be performed for the following cases.

Shop N. [1234-56]  
Issue P [ 0p]  
Return P [ 0p]  
History [ 0]  
Waiting manual trans

'04/05/20 15:00:25

If the time in automatic communication is exceeded because of an abort during while the system is communicating with the computer in the office, a message is displayed in the fifth line to request manual communication.

Memory card full!  
Transfer data

'04/05/20 15:00:25

When the amount of space available left on the memory card (compact flash card) falls below 10% when the communication function is enabled, manual communication is periodically requested.

### Delete all history

Memory card full!  
Transfer history

'04/05/20 15:00:25

When the amount of space available left on the memory card (compact flash card) falls below 10% when the communication function is disabled, the loading of history information is periodically requested.

If necessary, load that history information from the memory card (compact flash card) directly to the office computer, then batch delete that history information. (⇒ See page 27)

# Basic Operations

## • Adding points

Points are added according to the amount paid for a product.

### ▶ When the multiplier of the points is not changed

No.	[A123456-00200]
Total Pnt	[750p]
Multiplier	[X1]
Sales	[\$ _ ]
'04/05/20 15:00:25	

- ① Insert a member card while the system is idling.
- ② Input of the sales price is requested. Use the tenkeys to input the price, then press **OK**.

**i** The multiplier for the term is initialized if there is a term set with a multiplier for that term.

### When additional points are set (⇒ See pages 38 and 41)

Add point?
<b>YES</b> [NO]
'04/05/20 15:00:25

- ③ A confirmation for adding additional points is displayed. Select **OK** for [YES] and **SET** for [NO]. [YES] and [NO] can be switched using **F3** and **F4**. Use **OK** to confirm the selection.

### When ECO points are set (⇒ See pages 38 and 41)

Add ECO point?
<b>YES</b> [NO]
'04/05/20 15:00:25

- ④ A confirmation for adding ECO points is displayed. Select **OK** for [YES] and **SET** for [NO]. [YES] and [NO] can be switched using **F3** and **F4**. Use **OK** to confirm the selection.

### When welcome points are set (⇒ See pages 38 and 41)

No.	[A123456-00200]
This time P	[+25p]
Total Pnt	[775p]
'04/05/20 15:00:25	

- ⑤ Welcome points are automatically added.  
**i** Welcome points can only be added once on the same day and in the same shop.
- ⑥ Points are added and the member card data and the display are changed.
- ⑦ The member card is discharged and the system idles again.



## Basic Operations

### ► When change the point multiplier

No.	[A123456-00200]
Total Pnt	[750p]
Multiplier	[X1]
Sales	[\$ _ ]
'04/05/20 15:00:25	

① Insert a member card while the system is idling.

② Press the **(RATE)** switch.

**i** The multiplier for the term is initialized if there is a term set with a multiplier for that term.

Input point multiplier	
[X1]	
'04/05/20 15:00:25	

③ Input the multiplier and press **(OK)**.

Any multiplier between 1 and 10 can be input. If a multiplier over 11 is input, the system requests you to re-input a new multiplier.

**i** The multiplier is effective only for converting points one time after it is changed. It is not permanent.

Also, if transmission with the office computer ends normally or in error, the office computer is set to X 1.

No.	[A123456-00200]
Total Pnt	[750p]
Multiplier	[X2]
Sales	[\$ _ ]
'04/05/20 15:00:25	

④ Input of the sales price is requested. Use the tenkeys to input the price, then press **(OK)**.

### When additional points are set (⇒ See pages 38 and 41)

Add point?	
<b>[YES]</b>	
[NO]	
'04/05/20 15:00:25	

⑤ A confirmation for adding additional points is displayed.

Select **(OK)** for [YES] and **(SET)** for [NO].

[YES] and [NO] can be switched using **(F3)** and **(F4)**. Use **(OK)** to confirm the selection.

### When ECO points are set (⇨ See pages 38 and 41)

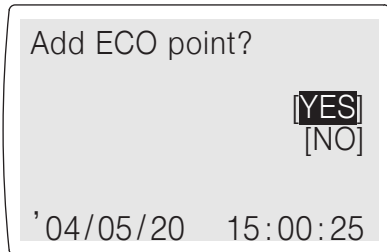

- ⑥ A confirmation for adding eco-points is displayed.  
Select **OK** for [YES] and **SET** for [NO].  
[YES] and [NO] can be switched using **F3** and **F4**. Use **OK** to confirm the selection.

### When welcome points are set (⇨ See pages 38 and 41)

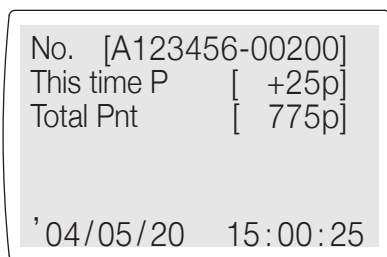

- ⑦ Welcome points are automatically added.  
**i** Welcome points can only be added once on the same day and in the same shop.
- ⑧ All of the points that are set are added and the member card data and the display are changed.
- ⑨ The member card is discharged and the system idles again.

### ○ When a member card's valid period has expired when adding points

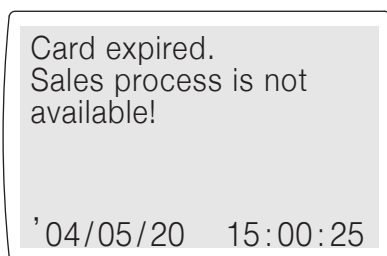

The card is rejected. (This is valid only when the card has an effective period set.)

## Basic Operations

### • Exchanging points

Points are subtracted from the card when the points accumulated are exchanged for a product or certificates.

Insert card to  
exchange points

'04/05/20 15:00:25

- ① Press the **EXCH** switch while the system is idling.
- ② Insert a member card.

No. [A123456-00200]  
Total Pnt [ 1150p]  
Exc Pnt [ \_p]

'04/05/20 15:00:25

- ③ Input of the Redeem point is requested. Use the tenkeys to input the units for point conversion ( ⇨ see pages 38 and 41), then press **EXCH**.

No. [A123456-00200]  
This time P [ -500p]  
Total Pnt [ 650p]

'04/05/20 15:00:25

- ④ Points are subtracted for the amount being converted, and the member card data and the display are changed.  
**i** The display shows the results of any adding or subtracting of points when the data is updated on the card.

### • Subtracting points by returning products

Points are subtracted according to the amount of the product being returned.

#### ▶ When the multiplier of the points is not changed

Insert card to  
return goods.

'04/05/20 15:00:25

- ① Press the **RTN** switch while the system is idling.
- ② Insert a member card.

No. [A123456-00200]  
Total Pnt [850p]  
Multiplier [ X1]  
Rtnd item [ \$ \_ ]

'04/05/20 15:00:25

- ③ Input of the price of the return item is requested. Use the tenkeys to input the price and press **OK**.  
**i** The multiplier for the term is initialized if there is a term set with a multiplier for that term.

No. [A123456-00200]  
 This time P [ -20p]  
 Total Pnt [ 830p]  
 '04/05/20 15:00:25

- ④ Points are subtracted for the amount being converted, and the member card data and the display are changed.

**i** The additional points, eco-points and welcome points which have been added when making a purchase are not subtracted.

### ► When change the point multiplier

Insert card to  
 return goods.  
 '04/05/20 15:00:25

- ① Press the **(RTN)** switch while the system is idling.

- ② Insert a member card.

- ③ Press the **(RATE)** switch.

**i** The multiplier for the term is initialized if there is a term set with a multiplier for that term.

Input point multiplier  
 [X1]  
 '04/05/20 15:00:25

- ④ Input the multiplier and press **(OK)**.

Any multiplier between 1 and 10 can be input. If a multiplier over 11 is input, the system requests you to re-input a new multiplier.

**i** The multiplier is effective only for converting points one time after it is changed. It is not permanent. Also, if communications with the office computer ends normally or in error, the office computer is set to X 1.

No. [A123456-00200]  
 Total Pnt [850p]  
 Multiplier [X2]  
 Rtn item [ \$ \_ ]  
 '04/05/20 15:00:25

- ⑤ Input of the price of the return item is requested. Use the tenkeys to input the price and press **(OK)**.

No. [A123456-00200]  
 This time P [ -40p]  
 Total Pnt [ 810p]  
 '04/05/20 15:00:25

- ⑥ Points are subtracted for the amount being converted, and the member card data and the display are changed.

**i** The additional points, eco-points and welcome points which have been added when making a purchase are not subtracted.

## Basic Operations

### • Inputting a password

A password is required to issue a member card or to change the settings.

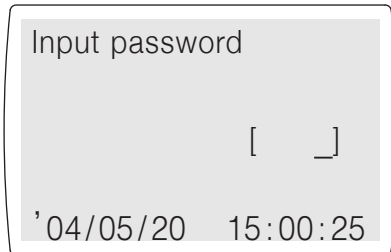

- ① When the input of a password is requested, input the 4 digit password, use the tenkeys to input the password and press **OK**. If it is correct, the screen proceeds to the next display.

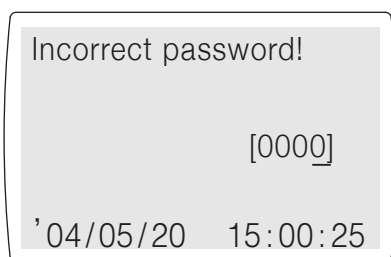

- ② If the password is incorrect and error is displayed.

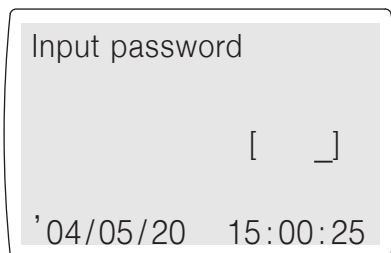

- ③ Input the password again, and press **OK**.

## • Correcting previous point operations

Only the previous points that were added or subtracted by purchasing an item, returning an item or converting points can be deleted.

Function 1  
**[Correct last issue]**  
 [Rewrite card]  
 [Issue new card]  
 [Set member's name]  
 '04/05/20 15:00:25

- ① Press **(F1)** while the system is idling.  
 In Function 1, use either **(F3)** or **(F4)** to select [Correct last item], and press **(OK)**.

Insert card to  
 correct last issue  
 '04/05/20 15:00:25

- ② Insert a member card.

Sales  
 No. [A123456-00200]  
 Last Pnt [ +50p]  
 Total Pnt [ 700p]  
 '04/05/20 15:00:25

- ③ The last operations, card number, the number of points remaining from the last time, and the current total number of points are displayed.

Correct data?  
**[YES]**  
 [NO]  
 '04/05/20 15:00:25

- ④ A confirmation for correcting the data is displayed.  
 Use **(OK)** to select [YES].  
 [YES] and [NO] can be switched using **(F3)** and **(F4)**. Use **(OK)** to confirm the selection.  
 If [NO] is selected, the system idles again.

No. [A123456-00200]  
 This time P [ +50p]  
 Total Pnt [ 750p]  
 '04/05/20 15:00:25

- ⑤ The member card data and display are re-written.  
**i** Only the device that has the operating information of the last time, and the same shop number can make corrections. The device control number does not have to be the same.

## Basic Operations

### • Re-writing a member card

Member cards can be re-written when the information on the card is not clear.

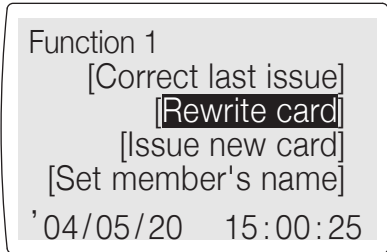

- ① Press **F1** while the system is idling.  
In Function 1, use either **F3** or **F4** to select [Rewrite card], and press **OK**.

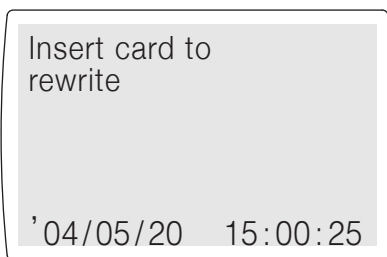

- ② Insert a member card.
- ③ The display information of the member card is re-written.

### • Issuing a new member card

This registers a member number for a new customer and issued them a new card.

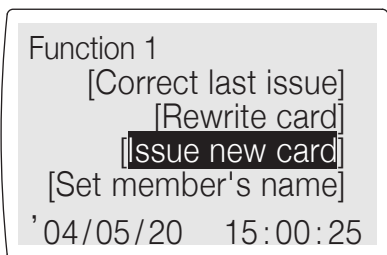

- ① Press **F1** while the system is idling.  
In Function 1, use either **F3** or **F4** to select [Issue new card], and press **OK**.

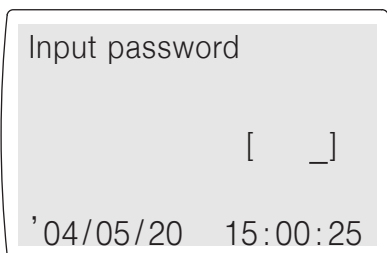

- ② After the message "Issue new card" is displayed, the system request a password.  
Input the password, and press **OK**. (⇒ See page 16)

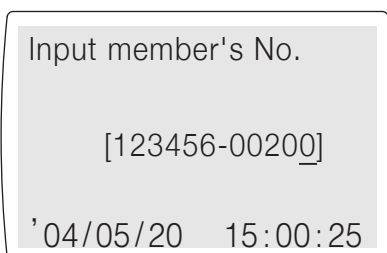

- ③ Use the tenkey to input the member's number and press **OK**.  
**i** Normally, the new member number is incremented by 1 from the previously issued new member number. However, there are cases in which it may not be a consecutive number because of setting changes made on the compact flash card.

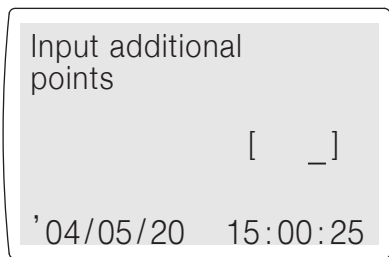

- ④ Input the additional points when issuing the new card.  
If there are no additional points being added, input "0" and press

**OK**.

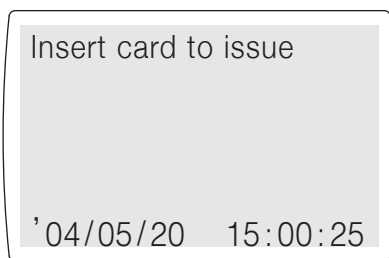

- ⑤ Insert a new member card.

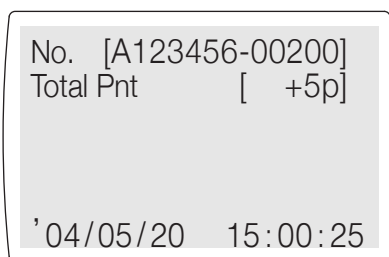

- ⑥ The data is entered and the display is written onto the member card.

**i** The message "Insert card to issue" is displayed. This makes it possible to continue issuing new member cards. Insert a new member card to continue issuing a new card.

In this case, member numbers are automatically set consecutively. In other words, each subsequently issued member card is increment by 1 from the previously issued member card.

To stop this operation, press **CLR**.

### • Registering a member

This registers a member customer's name.

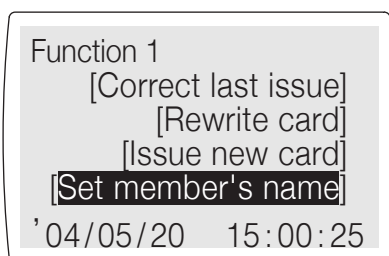

- ① Press **F1** while the system is idling.

In Function 1, use either **F3** or **F4** to select [Member's name], and press **OK**.

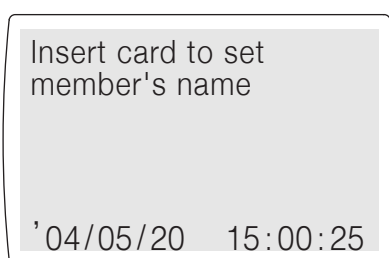

- ② Insert a member card.



## Basic Operations

Input member's name  
(max. 14 characters)

[            ]

'04/05/20 15:00:25

- ③ Input the name of the member customer, and press **OK**.  
(⇒ See pages 5 for details on inputting characters.)

### • Re-issuing a member card

Re-issue a member card when the magnetic information on the current card can no longer be read.

Function 1  
[Set member's name]  
**[Reissue card]**  
[Exchange card]  
[Void card]

'04/05/20 15:00:25

- ① Press **F1** while the system is idling.  
In Function 1, use either **F3** or **F4** to select [Reissue card], and press **OK**.

Input password

[            ]

'04/05/20 15:00:25

- ② After the message "Reissue card" is displayed, the system request a password.  
Input the password, and press **OK**. (⇒ See page 16)

Insert card to  
reissue

'04/05/20 15:00:25

- ③ Insert a new card.  
Then, input the contents on the original card by following the directions on the device display.

Input shop  
administration no.

[            ]

'04/05/20 15:00:25

- ④ Use the tenkeys to input the shop administration number and press **OK**.

Input machine  
administration no.

[ \_ ]

'04/05/20 15:00:25

- ⑤ Use the tenkey to input the machine's administration number and press **OK**.

Input member's No.

[123456-00200]

'04/05/20 15:00:25

- ⑥ Use the tenkey to input the member's number and press **OK**.

Input total point

[000332p]

'04/05/20 15:00:25

- ⑦ Use the tenkey to input the total number of points and press **OK**.

Input total number  
of card usages

[ \_times]

'04/05/20 15:00:25

- ⑧ Use the tenkeys to input the number of times the card has been used [ times] and press **OK**.

Input term of  
validity

['04/05/20]

'04/05/20 15:00:25

- ⑨ Use the tenkeys to input the valid date and press **OK**.

No. [A123456-00200]  
Total Pnt [332p]

'04/05/20 15:00:25

- ⑩ The data is recorded and written to the new card.



### Caution

Always retrieve the original card and discard it.

## Basic Operations

### • Exchanging a member card

Exchange a member card when the printing area of the card has degraded.

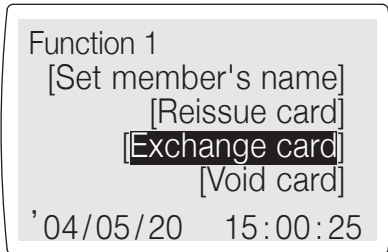

- ① Press **F1** while the system is idling.  
In Function 1, use either **F3** or **F4** to select [Invalidate member card], and press **OK**.

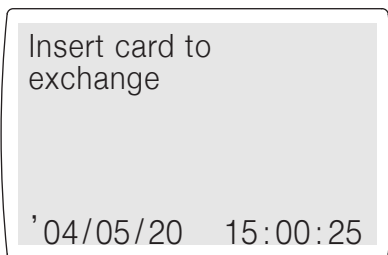

- ② Insert the current member card.

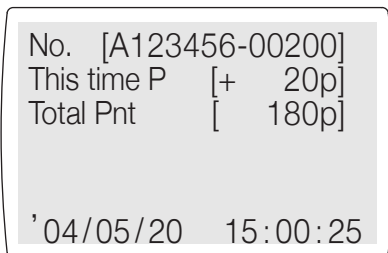

- ③ The current information of the card is displayed.

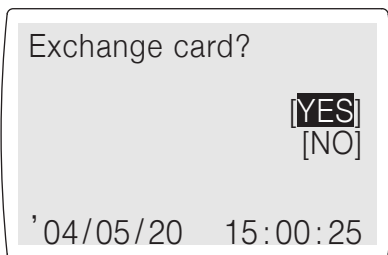

- ④ A confirmation for exchanging the card is displayed.  
Use **OK** to select [YES]. [YES] and [NO] can be switched using **F3** and **F4**. Use **OK** to confirm the selection.  
If [NO] is selected, the system idles again.

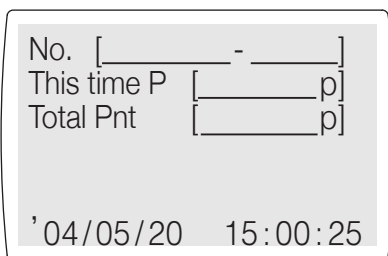

- ⑤ The data on the current member card becomes invalidated and the customer number and point display are erased.  
⑥ "This card was exchange" is printed onto the invalidated card and then the card is ejected from the machine.

Insert blank card

'04/05/20 15:00:25

⑦ Insert a new member card.

No. [A123456-00200]  
 This time P [+ 20p]  
 Total Pnt [ 180p]

'04/05/20 15:00:25

⑧ The current data is recorded and written to the new card.



### Caution

To prevent erasing data because of a mis-operation of the machine, it is not possible to terminate operation using **CLR** while using "Exchange member card."

## • Invalidating a member card

This invalidates customer registration and points when a customer quits membership.

Function 1  
 [Set member's name]  
 [Reissue card]  
 [Exchange card]  
 [Void card]

'04/05/20 15:00:25

① Press **F1** while the system is idling. In Function 1, use either **F3** or **F4** to select [Void card], and press **OK**.

Insert card to void

'04/05/20 15:00:25

② Insert the member card to void.

No. [A123456-00200]  
 This time P [+ 10p]  
 Total Pnt [ 110p]

'04/05/20 15:00:25

③ The current information of the card is displayed.

## Basic Operations

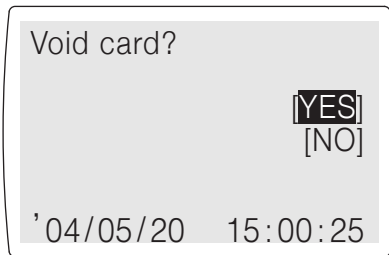

- ④ A confirmation for voiding the card is displayed.

Use **OK** to select [YES].

[YES] and [NO] can be switched using **F3** and **F4**. Use **OK** to confirm the selection.

If [NO] is selected, the system idles again.

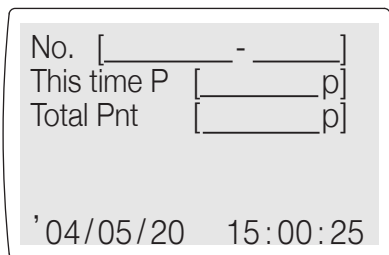

- ⑤ The data on the current member card becomes invalidated and the customer number and point display are erased.

- ⑥ "This card was void" is printed onto the voided card and then the card is ejected from the machine.

**i** If a card is not recognized normally as a member card, the member card data and print surface are voided, but because the member card number cannot be identified, it cannot be saved in the compact flash card as history information. Also, the daily total information (the number of member cards that have been voided) is also not targeted.

### • Cleaning

Clean the machine when it is dirty inside and when errors occur with notable frequency. ( ⇨ See page 54)

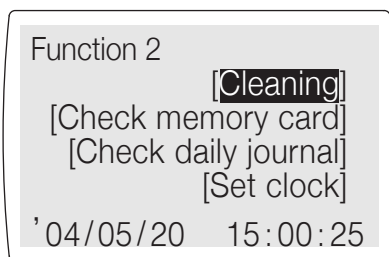

- ① Press **F1** while the system is idling.

In Function 2, use either **F3** or **F4** to select [Cleaning], and press **OK**.

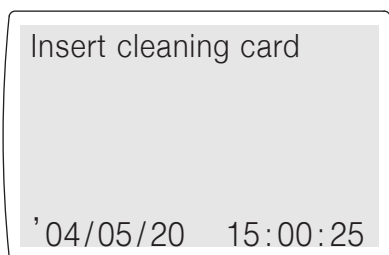

- ② Insert the cleaning card.

- ③ The device automatically cleans itself.

### • Automatic communication

The system automatically communicates with the office computer when the set time is reached, when the communication function is enabled.

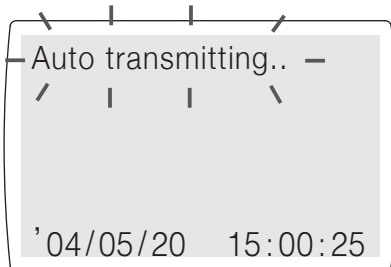

① When the preset time is reached ( ⇨ see page 41), the system automatically begins communicating with the office computer. It uploads history information and downloads settings.

② If communications are aborted because the line is busy, the system will retry after 10 seconds. The system will retry 2 times.

**i** The journal data is erased when this ends normally and the history information is saved as a backup file. Up to 10 files can be saved as a backup. When this is exceeded, the oldest file is erased. The multiplier is set to a value by the office computer, but if this is aborted, the multiplier is returned to 1.

### • Manual transmission

Communication in manual mode is possible if it is interrupted for some reason while in automatic mode to communicate with the office computer.

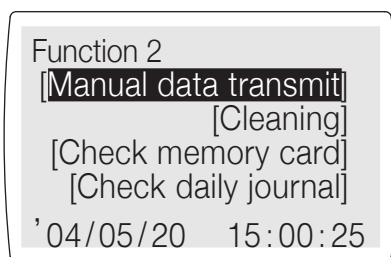

① Press **(F2)** while the system is idling.

In Function 2, use either **(F3)** or **(F4)** to select [Manual data transmit], and press **(OK)**.



② A confirmation of manual communication is displayed. To continue, select [YES].

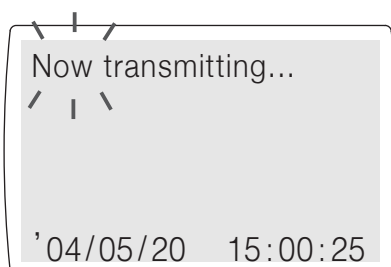

③ Communication with the office computer begins. History information is uploaded, and settings are downloaded in the communication.

## Basic Operations



④ A retry confirmation is displayed when there is a failure in communications because the line is busy. To retry, select [YES].

**i** The journal data is erased when this ends normally and the history information is saved as a backup file. Up to 10 files can be saved as a backup. When this is exceeded, the oldest file is erased. The multiplier is set to a value by the office computer, but if this is aborted, the multiplier is returned to 1.

### • Delete history

This deletes unnecessary history information.

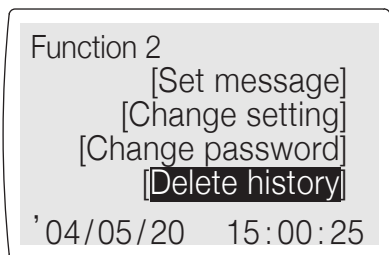

① Press **F2** while the system is idling. In Function 2, use either **F3** or **F4** to select [Delete history], and press **OK**.

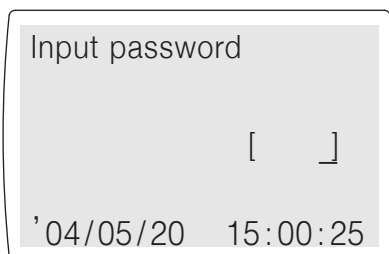

② After the message "Delete history" is displayed, the system request a password.

Input the password, and press **OK**. (➡ See page 16)



③ A confirmation of deleting the history information is displayed.

Use **OK** to select [YES].

[YES] and [NO] can be switched using **F3** and **F4**. Use **OK** to confirm the selection.

If [NO] is selected, the system idles again.

**i** The history information is saved as a backup when this ends normally. Up to 10 files can be saved as a backup. When this is exceeded, the oldest file is erased.

### • Delete all history

This deletes all backup files and history information.

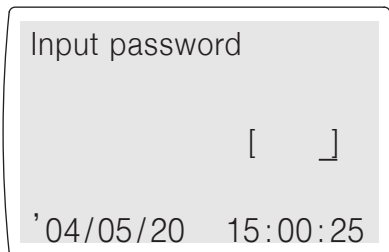

- ① Turn on the power while pressing **EXCH**.
- ② After the message "Delete all history" is displayed, the system request a password.  
Input the password, and press **OK**. (⇨ See page 16)



- ③ A confirmation of deleting all history information is displayed.  
Use **OK** to select [YES].  
[YES] and [NO] can be switched using **F3** and **F4**. Use **OK** to confirm the selection.  
If [YES] is selected, the journal information, history information, and backed up history information are all erased.  
If [NO] is selected, the system idles again.

### **Caution**

With regard to the [Delete history] and [Delete all history] functions, when history information is loaded directly to the office computer from the compact flash card, the history is not erased from the compact flash card by the office computer. These histories must be erased using the operations described above.



# Welcome point only

## • Adding points

The machine can be set as a "machine for welcome points" when setting the system ( ⇨ see page 41). After making the setting, points are added to customer member cards when they visit the shop.

Insert card to add points  
  
'04/05/20 15:00:25

The set number of points are added ( ⇨ see page 51) when the member card is inserted while the system is idled. The card data and print are changed.

Shop N. [1234-56]  
Issue P [ 0p]  
Return P [ 0p]  
History [ 0]

"Insert card to add welcome point " and "Shop No, Issue point, History " are displayed alternately.

Can not add welcome point on the same day at the same shop  
  
'04/05/20 15:00:25

**i** If a card that has already been added with a welcome point on the same day and at the same shop, "Can not add welcome point on the same day at the same shop" is displayed and the addition of the welcome point is rejected.

Void card!  
Can not add welcome point  
  
'04/05/20 15:00:25

**i** If a card that has expired is inserted, already been added with a welcome point on the same day and at the same shop, "Void card! Can not add welcome point" is displayed and the addition of the points is rejected.

## • Delete all history

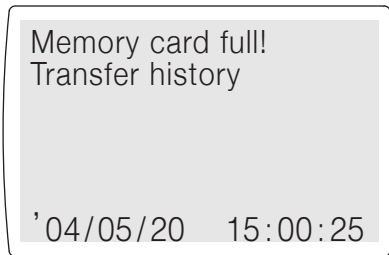

When the amount of space available left on the memory card (compact flash card) falls below 10%, the loading of history information is periodically requested.

If necessary, load that history information from the memory card (compact flash card) directly to the office computer, then batch delete that history information. (⇒ See page 27)

## • Cleaning

Clean the machine when it is dirty inside and when errors occur with notable frequency. (⇒ See page 54)

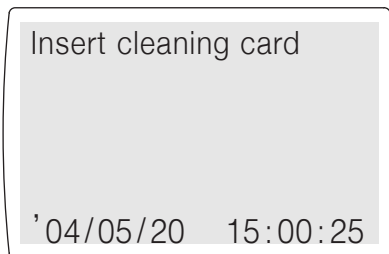

- ① Press **F2** while the system is idling. In Function 2, use either **F3** or **F4** to select [Cleaning], and press **OK**.
- ② Insert the cleaning card.
- ③ The device automatically cleans itself.

## • Adjusting the display

The contrast of the display can be adjusted.

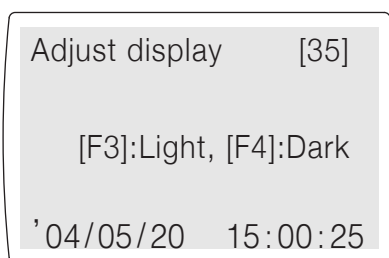

- ① Press **F2** while the system is idling. In Function 2, use either **F3** or **F4** to select [Adjust display], and press **OK**.
- ② **F3** lightens the display; **F4** darkens the display. When you have your desired contrast, press **OK**.

**i** Any setting between 0 and 63 is possible.  
Values between 30 and 40 are in the standard range.

# Check Operations

## • Checking the current settings

You can check the current machine settings. Use the **(OK)** key to call up the next settings to check. Use the **(CLR)** key to quit checking and to return to the machine to its idling state.

Shop admin No. [1234]  
Machine admin No. [56]  
'04/05/20 15:00:25

Press the **(SET)** switch.  
After the message "Verify settings" is displayed, the shop administration number and the machine administration number are displayed.

Print area [Single window type]  
Media type ID [ 0]  
'04/05/20 15:00:25

The type of member card print area and the media type ID number are displayed.

**i** Contact your dealer for the medial type ID.

Point convert ratio  
[\$ 1.00]  
[ 1p]  
'04/05/20 15:00:25

**When member rank settings are disabled** (⇒ See page 41)

The point conversion ratio is displayed.

**i** This is not displayed when member rank settings are valid. Ranks C to A point conversions and ranks B and A threshold values are displayed.

C member point convert ratio  
[\$ 1.00]  
[ 1p]  
'04/05/20 15:00:25

**When member rank settings are enabled** (⇒ See page 41)

The point conversion ratio for member rank C is displayed.

B member point convert ratio  
[\$ 1.00]  
[ 2p]  
'04/05/20 15:00:25

The point conversion ratio for member rank B is displayed.

A member point  
convert ratio

[\$ 1.00]  
[ 3p]

'04/05/20 15:00:25

The point conversion ratio for member rank A is displayed.

B member threshold

[ 5000p]

A member threshold

[ 8000p]

'04/05/20 15:00:25

The threshold values for member ranks B and A are displayed.

Term of multiplier  
no.1 (date)

[Valid]  
[08/10~08/20]  
[X02]

'04/05/20 15:00:25

When the term of the multiplier 1 (Date) is enabled ( ⇨ See page 41)

The target date and term multiplier are displayed.

Term of multiplier  
no.2 (time)

[Valid]  
[10:00~11:00]  
[X02]

'04/05/20 15:00:25

When the term of the multiplier 2 (Time) is enabled ( ⇨ See page 41), the targeted band of time and the multiplier for that term are displayed.

## Check Operations

```
Additional point [ 1p]
ECO point [ 1p]
'04/05/20 15:00:25
```

When applying points according to the price of customer purchases, the additional points added or the ECO points are displayed.

**i** Additional point and ECO point are added only when [YES] is selected in the confirmation display when adding points.

```
Welcome point [ 1p]
Redeem point unit [ 500p]
'04/05/20 15:00:25
```

When applying points according to the price of customer purchases, the welcome points added automatically are displayed. Also, the number of points that can be redeemed is displayed for redeeming points.

```
Set term of validity [from date of use]
Term of validity [12months]
'04/05/20 15:00:25
```

Displays the term of validity setting.

```
Transmission [Valid]
Host Tel No. [0W*****]
'04/05/20 15:00:25
```

When setting the transmission with the office computer, or when transmission is enabled ( ⇨ See page 41), the telephone number of the target for transmission is also displayed.

**i** If there is 0 transmissions, "0W" which means there are no transmissions, is displayed at the header section of the transmission telephone number.

```
Dial method [****dial]
Transmission time [22:30]
'04/05/20 15:00:25
```

When transmission with the office computer is enabled, the dialing method and the transmission time are displayed. If transmission is disabled, nothing is displayed.

## • Checking the compact flash card

Checking the amount of space on the compact flash card

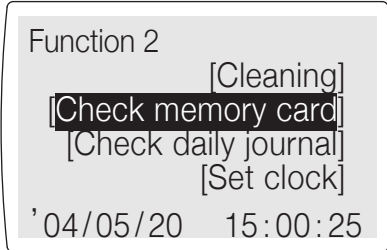

- ① Press **F2** while the system is idling. In Function 2, use either **F3** or **F4** to select [Memory card], and press **OK**.

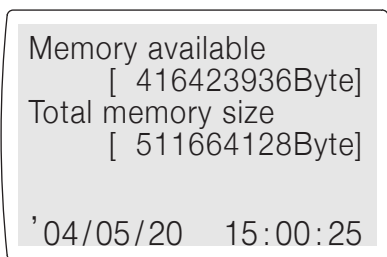

- ② After the message "Check memory card" is displayed, the system displays the total memory size and the available memory. The system returns to an idle state using **OK** or **CLR**.

**i** The writing to the compact flash cards is limited by the number of cases in the history, regardless of the total compact flash card available memory.

## • Checking the journal data

The data collected in one day can be checked. Use the [Execute] key to call up the next settings to check. Use the [Correction] key to quit checking and to return to the machine to its idling state.

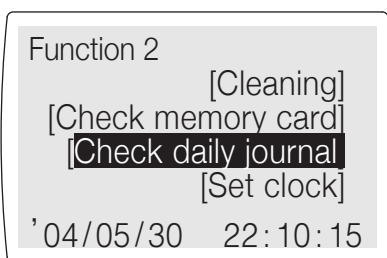

- ① Press **F2** while the system is idling. In Function 2, use either **F3** or **F4** to select [Journal data], and press **OK**.



- ② After the message "Check journal data" is displayed, the system displays the number of sales and the total number of points issued with the sales.

**i** Corrections made by returns are not reflected in this data.

## Check Operations

```
Redeem points
      [      1times]
      [      500p]

'04/05/30  22:10:15
```

The number of points converted and the total number of points are displayed.

```
Returned goods
      [      2times]
      [     204p]

'04/05/30  22:10:15
```

The number of times items were returned and the total value of the returns, and the total number of points associated with the returns are displayed.

```
Issue new card
      [      3times]
      [       9p]

'04/05/30  22:10:15
```

The number of cards that were issued, and the total number of additional points added when issued are displayed.

```
Reissue
      [      0times]
      [       0p]

'04/05/30  22:10:15
```

The number of cards that were reissued, and the total cumulative number of points by the re-issue are displayed.

```
Exchange card
      [      0times]
Old card     [      0times]

'04/05/30  22:10:15
```

The number of card exchanges and number of voided cards are displayed.

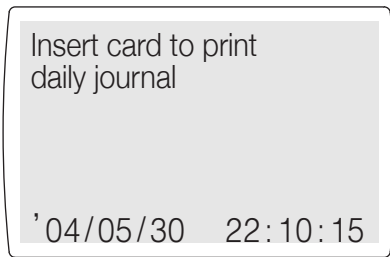

Insert a card to print the journal data.



### Caution

Always use a journal data card. Do not use a member card. If a member card is used, information on the card will be erased.

Journal	'04/05/30
Sold item	22tms 738p
Redeem P	1tms 500p
Rtnd gds	2tms 204p
Issued C	3tms 9p
Reissued C	0tms 0p
Exc card	0tms
Void card	0tms

Information relating to journal results are printed on the journal card as shown at left.



# Settings and Making Setting Changes

## • Setting the date and time

This sets the date and time. Also, it is possible to set time corrections in weekly units.

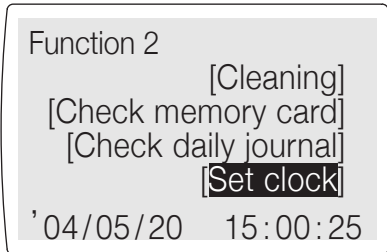

- ① Turn on the power while pressing **CLR**, or press **F2** while the system is idling. In Function 2, use either **F3** or **F4** to select [Clock], and press **OK**.



- ② Use the tenkey to input the date and time, and press **OK**.  
If not changing the current time, press **CLR** to proceed to setting the time correction.

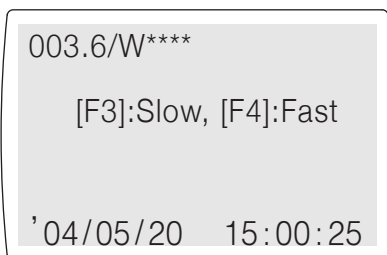

- ③ The time correction input display is called up.  
Press **F3** to delay the clock by 1.8 seconds, each time it is pressed. The second setting forwards the clock in 1.8 second intervals by pressing **F4**. Then, press **OK**.

## Settings and Making Setting Changes

### • Setting messages

Any messages for campaign information or shop information can be printed and switched for any occasion.



① Press **F2** while the system is idling. In Function 2, use either **F3** or **F4** to select [Message], and press **OK**.

② After the message "Set message" is displayed, from 1 to 3 lines of messages for small window type cards, and from 1 to 10 lines of messages for large window type cards can be changed, or can be checked in order.

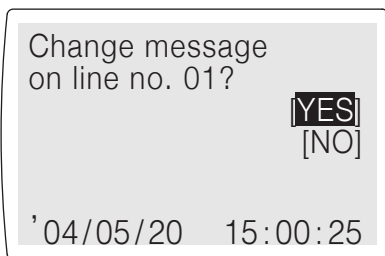

③ Use **OK** to select [YES].

[YES] and [NO] can be switched using **F3** and **F4**. Use **OK** to confirm the selection.

If [NO] is selected, a check for changing the next line is displayed. If [YES] is selected, the system proceeds to the input screen.

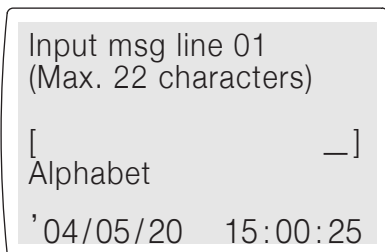

④ Input your message.

(⇒ See pages 5 for details on inputting characters.)

After completing your input, press **OK**. To make the line blank, where there was a message, do not input anything, and press **OK**.

# Settings and Making Setting Changes

## • Changing settings relating to points

It is possible to change settings such as for points for term multiplier, etc.

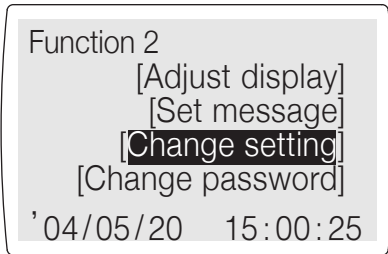

- ① Press **F2** while the system is idling.  
In Function 2, use either **F3** or **F4** to select [Setting], and press **OK**.

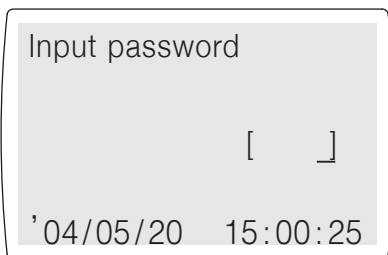

- ② After the message "Change setting" is displayed, the system request a password.  
Input the password, and press **OK**. (➡ See page 16)

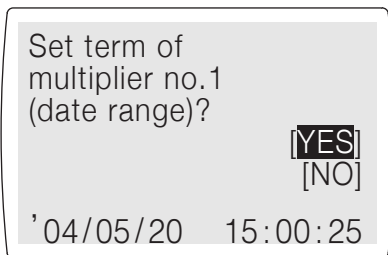

A confirmation for setting the term of multiplier 1 (Date) is displayed?  
Select **OK** for [YES] and **CLR** for [NO].  
[YES] and [NO] can be switched using **F3** and **F4**. Use **OK** to confirm the selection.

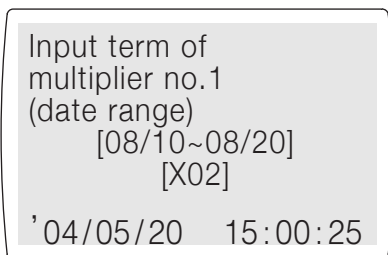

To set the term of multiplier 1 (Date), use the tenkeys to input the targeted term and multiplier for the term.  
Then, press **OK**.

**i** If [NO] is selected on the previous screen, the setting screen is not displayed.

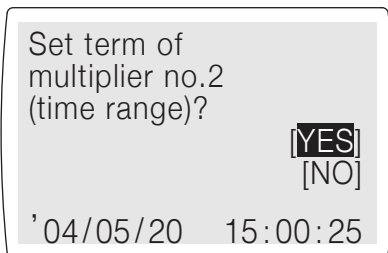

A confirmation for setting the term of multiplier 2 (Time) is displayed?  
Select **OK** for [YES] and **CLR** for [NO].  
[YES] and [NO] can be switched using **F3** and **F4**. Use **OK** to confirm the selection.

## Settings and Making Setting Changes

Input term of multiplier no.2 (time range)  
[10:00~11:00]  
[X02]  
'04/05/20 15:00:25

To set the term of multiplier 2 (Time), use the tenkeys to input the targeted time frame and multiplier for the time.

Then, press **OK**.

**i** If [NO] is selected on the previous screen, the setting screen is not displayed.

Input additional point  
[ \_ p]  
'04/05/20 15:00:25

Use the tenkeys to set the number of points to add when applying points according to the price of customer purchases, and press **OK** to confirm.

**i** A check is displayed when adding additional points. They are added only by selection [YES].

If set to 0 points, no confirmation screen will be displayed when a sale occurs.

Input ECO point  
[ \_ p]  
'04/05/20 15:00:25

Use the tenkeys to set the number of points to add when applying ECO points according to the price of customer purchases, and press **OK** to confirm.

**i** A check is displayed when adding ECO points. They are added only by selection [YES].

If set to 0 points, no confirmation screen will be displayed when a sale occurs.

Input welcome point  
[ \_ p]  
'04/05/20 15:00:25

Use the tenkeys to set the number of points to automatically add when a customer visits the shop according to the price of customer purchases, and press **OK** to confirm.

Input redeem point unit  
[ \_ p]  
'04/05/20 15:00:25

Use the tenkeys to set how many points can be exchanged in a point redemption plan, and the number of points that are the unit for exchange points, and press **OK** to confirm.

**i** Even if the term multipliers for points are all enabled, and the purchase is within the term, settings made by keys take priority.

When the keys are not used, the term of the multiplier 1 (Date) has priority over term of the multiplier 2 (Time).

## Settings and Making Setting Changes

### • Changing the password

The currently set password can be set to a new password.

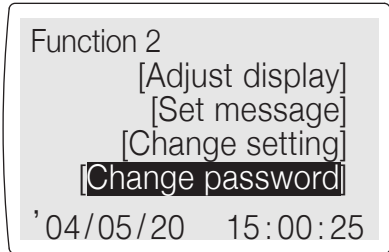

- ① Press **F2** while the system is idling. In Function 2, use either **F3** or **F4** to select [Message], and press **OK**.

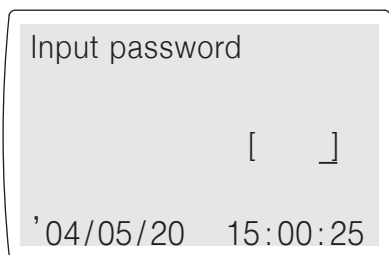

- ② After the message "Change password" is displayed, the system request a password.

Input the current password, and press **OK**.

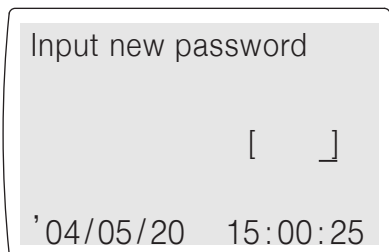

- ③ The system prompts you to input a new password. Input the new password, then press **OK**.

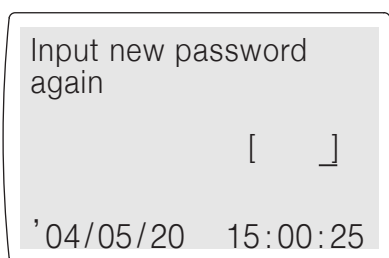

- ④ The system prompts you to input the new password again, to confirm that it is correct.

Input the new password, then press **OK**.

## • Setting the system

Various system settings can be made.

### ▶ How to make settings without using a system setting card

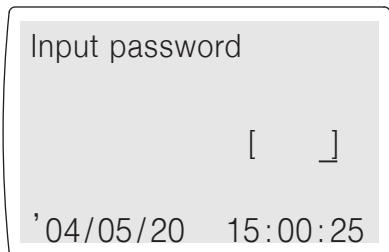

- ① Turn on the power while pressing the **OK** switch.
- ② After the message "Set memory card" is displayed, the system request a password.  
Input the password, and press **OK**. (⇨ See page 16)

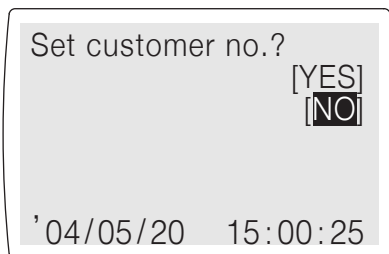

If customer numbers have been set in advance, this confirms whether to reset the customer number.  
Select **OK** for [YES] and **CLR** for [NO].  
[YES] and [NO] can be switched using **F3** and **F4**. Use **OK** to confirm the selection.

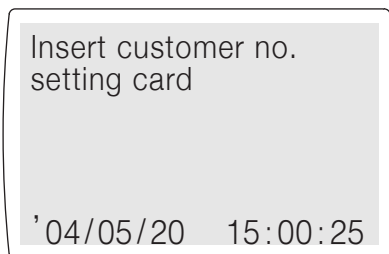

If [YES] is selected in this confirmation to reset the customer number, the system requests that the customer No. setting card be inserted. Insert customer no. setting card. The customer number information is read, and then the card is ejected.

**i** Customer number setting cards can be obtained from your dealer.

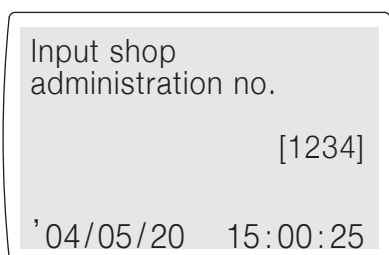

Use the tenkeys to input the shop administration number and press **OK** to confirm.

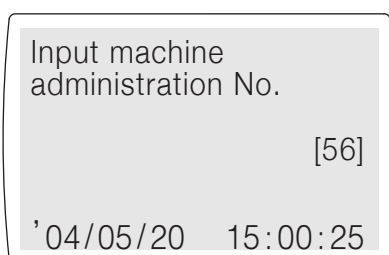

Use the tenkeys to input the machine administration number and press **OK** to confirm.

## Settings and Making Setting Changes

Set with system setting card?

[NO]  
[YES]

'04/05/20 15:00:25

A confirmation for setting using a system setting card is displayed?

Use **CLR** to select [NO].

[YES] and [NO] can be switched using **F3** and **F4**. Use **OK** to confirm the selection.

Select operation mode

[Normal]  
[Welcome point only]

'04/05/20 15:00:25

If not setting using a system setting card, a screen is displayed to confirm whether to use the system for normal operations, or only for welcome points?

Select **OK** for [Normal] and **CLR** for [Welcome point only].

[Normal] and [Welcome point only] can be switched using **F3** and **F4**. Use **OK** to confirm the selection.

### If [Normal] is selected:

➔ See the settings made from page 52 when [Normal] is selected.

Select card printing type

[Small window type]  
[Large window type]

'04/05/20 15:00:25

Select the card printing type.

Select **OK** for [Small window type] and **CLR** for [Large window type].

[Small window type] and [Large window type] can be switched using **F3** and **F4**. Use **OK** to confirm the selection. Input media type ID

Input media type ID

[ \_ ]

'04/05/20 15:00:25

Input the media type ID.

**i** Contact your dealer for the medial type ID.

Set member rank?

[YES]  
[NO]

'04/05/20 15:00:25

A confirmation for setting member rank is displayed?

Select **OK** for [YES] and **CLR** for [NO]. [YES] and [NO] can be switched using **F3** and **F4**. Use **OK** to confirm the selection.

## Settings and Making Setting Changes

Input point  
convert ratio

[ \$ - ]  
[ - p ]

'04/05/20 15:00:25

### When not setting member rank:

Use the tenkeys to input the point ratio, and press **OK** to confirm. When setting member ranks, set the point ratio for each member rank and set the threshold for member ranks B and A.

Input member rank C  
point convert ratio

[ \$ - ]  
[ - p ]

'04/05/20 15:00:25

### When setting member rank:

Input the point conversion ratio for member rank C, and press **OK** to confirm.

Input member rank B  
point convert ratio

[ \$ - ]  
[ - p ]

'04/05/20 15:00:25

Input the point conversion ratio for member rank B, and press **OK** to confirm.

Input member rank A  
point convert ratio

[ \$ - ]  
[ - p ]

'04/05/20 15:00:25

Input the point conversion ratio for member rank A, and press **OK** to confirm.

Input member rank B  
threshold

[ 5000p ]

'04/05/20 15:00:25

Input the threshold for member rank B, and press **OK** to confirm. A member card that has accumulated points beyond the input threshold is handled as member rank B.



## Settings and Making Setting Changes

Input member rank A  
threshold

[ 8000p]

'04/05/20 15:00:25

Input the threshold for member rank A, and press **OK** to confirm. A member card that has accumulated points beyond the input threshold is handled as member rank A.

**i** If the setting value of the threshold for member rank A is less than the setting value for the threshold for member rank B, input is rejected. (The system will issue a warning beep.)

Set term of  
multiplier no. 1?  
(date range)

**YES**  
[NO]

'04/05/20 15:00:25

A confirmation for setting the term of multiplier 1 (Date) is displayed?

Select **OK** for [YES] and **CLR** for [NO].

[YES] and [NO] can be switched using **F3** and **F4**. Use **OK** to confirm the selection.

Input term of  
multiplier no. 1?  
(date range)

[07/01~07/15]  
[X03]

'04/05/20 15:00:25

To set the term of multiplier 1 (Date), use the tenkeys to input the targeted term and multiplier for the term.

Then, press **OK**.

**i** If [NO] is selected on the previous screen, the setting screen is not displayed.

Set term of  
multiplier no. 2?  
(time range)

**YES**  
[NO]

'04/05/20 15:00:25

A confirmation for setting the term of multiplier 2 (Time) is displayed?

Select **OK** for [YES] and **CLR** for [NO].

[YES] and [NO] can be switched using **F3** and **F4**. Use **OK** to confirm the selection.

Input term of  
multiplier no. 2?  
(time range)

[10:00~11:00]  
[X02]

'04/05/20 15:00:25

To set the term of multiplier 2 (Time), use the tenkeys to input the targeted time frame and multiplier for the time.

Then, press **OK**.

**i** If [NO] is selected on the previous screen, the setting screen is not displayed.

## Settings and Making Setting Changes

Input additional point

[ \_ p]

'04/05/20 15:00:25

Use the tenkeys to set the number of points to add when applying points according to the price of customer purchases, and press **OK** to confirm.

**i** A check is displayed when adding additional points. They are added only by selection [YES].

If set to 0 points, or it was confirmed that nothing was input, no confirmation screen will be displayed when a sale occurs.

Input ECO point

[ \_ p]

'04/05/20 15:00:25

Use the tenkeys to set the number of points to add when applying ECO points according to the price of customer purchases, and press **OK** to confirm.

**i** A check is displayed when adding additional ECO points. They are added only by selection [YES].

If set to 0 points, or it was confirmed that nothing was input, no confirmation screen will be displayed when a sale occurs.

Input welcome point

[ \_ p]

'04/05/20 15:00:25

Use the tenkeys to set the number of points to automatically add when a customer visits the shop according to the price of customer purchases, and press **OK** to confirm. If set to 0 points or it was confirmed that nothing was input, nothing will be added when a sale occurs.

Input redeem point unit

[ \_ p]

'04/05/20 15:00:25

Use the tenkeys to set how many points can be exchanged in a point redemption plan, and the number of points that are the unit for exchange points, and press **OK** to confirm.

Set term of validity?

[from date of issue]  
[from date of use]  
[NO]

'04/05/20 15:00:25

A confirmation for setting the term of validity is displayed.

[from date of issue] [form date of use] and [NO] can be switched using **F3** and **F4**.

Use **OK** to confirm the selection.

## Settings and Making Setting Changes

Input term of validity

[ \_months]

'04/05/20 15:00:25

To set the valid date, set the term.

Use the tenkey to a value between 1 and 99, and press **OK**.

**i** If [NO] is selected on the previous screen, the setting screen is not displayed.

Transmit data

**YES**

[NO]

'04/05/20 15:00:25

A confirmation for transmitting is displayed?

Select **OK** for [YES] and **CLR** for [NO].

[YES] and [NO] can be switched using **F3** and **F4**. Use **OK** to confirm the selection.

Add prefix "0"?

**YES**

[NO]

'04/05/20 15:00:25

A confirmation for adding the prefix 0 is displayed.

Select **OK** for [YES] and **CLR** for [NO].

[YES] and [NO] can be switched using **F3** and **F4**. Use **OK** to confirm the selection.

**i** If [NO] is selected on the previous screen, the setting screen is not displayed.

Input Tel. no. to dial

[ \_ ]

'04/05/20 15:00:25

Use the tenkeys to input the other party's telephone number for transmission, and press **OK**.

**i** If [NO] is selected on the transmission confirmation screen, the setting screen is not displayed.

Select dial method

**Tone**

[Pulse]

'04/05/20 15:00:25

Select the dialing method.

[Tone] and [Pulse] can be switched using **F3** and **F4**.

Use **OK** to confirm the selection.

**i** If [NO] is selected on the transmission confirmation screen, the setting screen is not displayed.

A tone dial is a "push-phone type."

A pulse dial is a "dial-up type."

## Settings and Making Setting Changes

Input data  
transmission time

[00:00]

'04/05/20 15:00:25

Use the tenkeys to input the transmission time, and press **OK**.  
Transmissions are performed with the office computer at the time set for each day.

**i** If [NO] is selected on the transmission confirmation screen, the setting screen is not displayed.

Issue system  
setting card?

**YES**  
[NO]

'04/05/20 15:00:25

A confirmation for issuing a system setting card is displayed?

Select **OK** for [YES] and **CLR** for [NO].

[YES] and [NO] can be switched using **F3** and **F4**. Use **OK** to confirm the selection.

Insert system  
setting card 1

'04/05/20 15:00:25

Insert the system setting card 1.

**i** If [NO] is selected on the previous screen, the setting screen is not displayed.

Insert system  
setting card 2

'04/05/20 15:00:25

Insert the system setting card 2.

**i** If [NO] is selected on the previous screen, the setting screen is not displayed.

## Settings and Making Setting Changes

<Example of a System Setting Card Print-out>

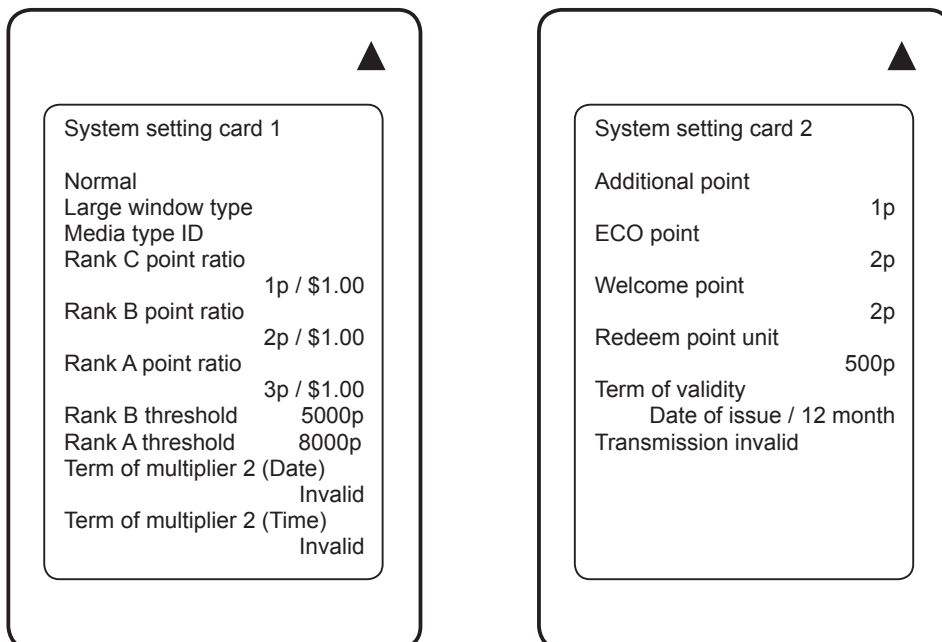

If you create a system setting card, the system settings can be automatically set by the magnetic data recorded on this system setting card when setting the system. This is a very convenient function.

### **Caution**

When operations for setting the system are completed, all journal data, history information and backed up history information is deleted, and the system is initialized. If history information remains, load those history files directly loaded to the office PC.

## Settings and Making Setting Changes

### ► How to set using the system setting cards

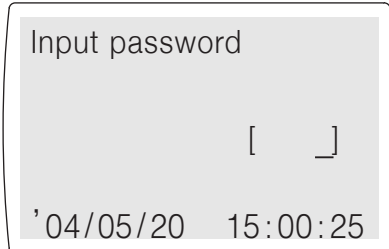

- ① Turn on the power while pressing the **OK** switch.
- ② After the message "Set memory card" is displayed, the system request a password.  
Input the password, and press **OK**. (⇒ See page 16)



If customer numbers have been set in advance, this confirms whether to reset the customer number.  
Select **OK** for [YES] and **CLR** for [NO].  
[YES] and [NO] can be switched using **F3** and **F4**. Use **OK** to confirm the selection.

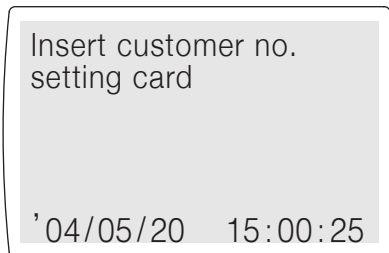

If [YES] is selected in this confirmation to reset the customer number, the system requests that the customer No. setting card be inserted. Insert customer No. setting card. The customer number information is read, and then the card is ejected.

**i** Customer number setting cards can be obtained from your dealer.

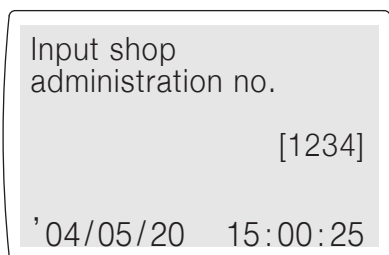

Use the tenkeys to input the shop administration number and press **OK** to confirm.

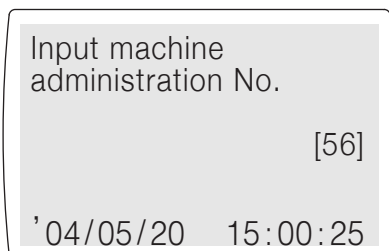

Use the tenkeys to input the machine administration number and press **OK** to confirm.

## Settings and Making Setting Changes

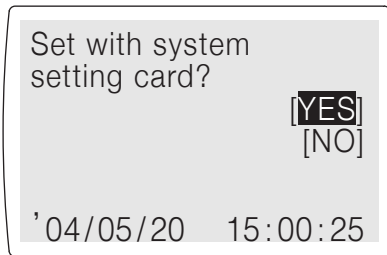

A confirmation for setting using a system setting card is displayed?

Use **OK** to select [YES].

[YES] and [NO] can be switched using **F3** and **F4**. Use **OK** to confirm the selection.

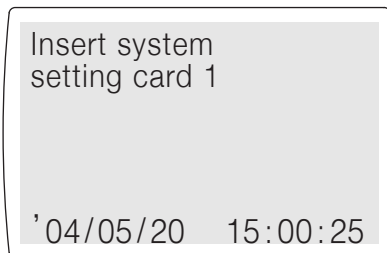

Insert the system setting card 1.

The system setting information recorded on system setting card 1 is automatically loaded to the machine.

After that data is loaded, the card is ejected.

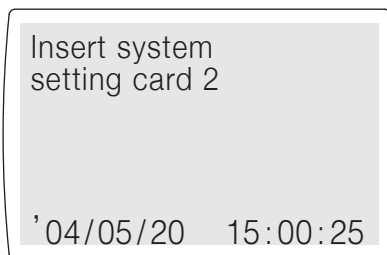

Insert the system setting card 2.

The system setting information recorded on system setting card 2 is automatically loaded to the machine.

After that data is loaded, the card is ejected.

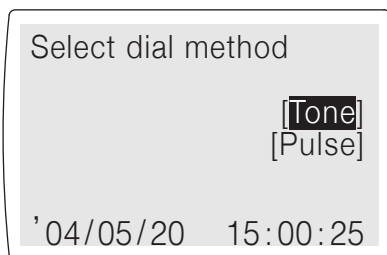

Select the dialing method.

[Tone] and [Pulse] can be switched using **F3** and **F4**.

Use **OK** to confirm the selection.

**i** A tone dial is a push-phone type.  
A pulse dial is a "dial-up" type.

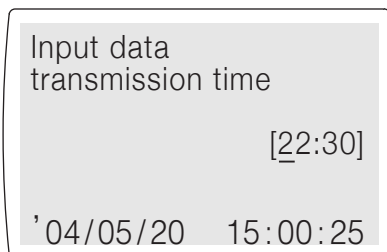

Use the tenkeys to input the transmission time, and press **OK**.

Transmissions are performed with the office computer at the time set for each day.

### **!** Caution

When operations for setting the system are completed, all journal data, history information and backed up history information is deleted, and the system is initialized. If history information remains, load those history files directly loaded to the office PC.

## Settings and Making Setting Changes

If [Welcome point only] is selected:

⇒ See the settings made from page 43 for [Normal] operations.



Select the card printing type.

Select **OK** for [Small window type] and **CLR** for [Large window type]. [Small window type] and [Large window type] can be switched using **F3** and **F4**. Use **OK** to confirm the selection.

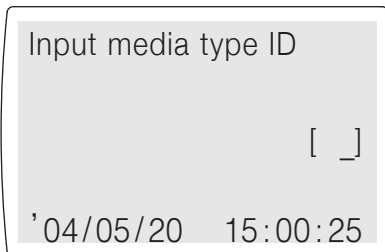

Input the media type ID.

**i** Contact your dealer for the medial type ID.

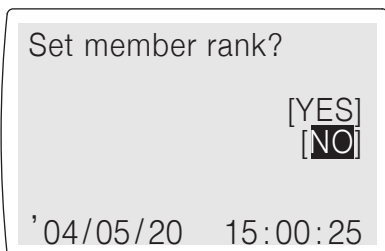

A confirmation for setting member rank is displayed?

Select **OK** for [YES] and **CLR** for [NO].

[YES] and [NO] can be switched using **F3** and **F4**. Use **OK** to confirm the selection.

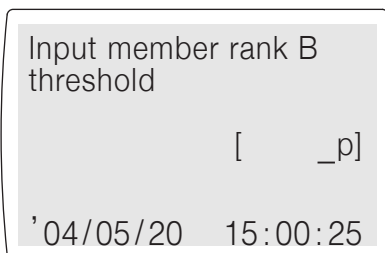

Input the threshold for member rank B, and press **OK** to confirm.

A member card that has accumulated points beyond the input threshold is handled as member rank B.

**i** If [NO] is selected on the previous screen, the setting screen is not displayed.

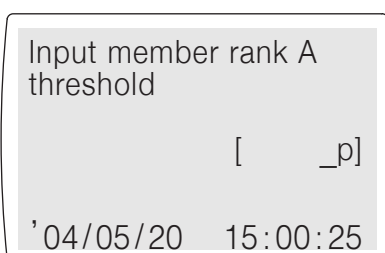

Input the threshold for member rank B, and press **OK** to confirm.

A member card that has accumulated points beyond the input threshold is handled as member rank B.

**i** If the setting value of the threshold for member rank A is less than the setting value for the threshold for member rank B, input is rejected. (The system will issue a warning beep.)

If [NO] is selected on the previous screen, the setting screen is not displayed.



## Settings and Making Setting Changes

Input welcome point

[ \_p]

'04/05/20 15:00:25

Use the tenkeys to set the number of points to automatically add when a customer visits the shop according to the price of customer purchases, and press **OK** to confirm.

If set to 0 points, or it was confirmed that nothing was input, nothing will be added when a sale occurs.

Set term of validity?

**[from date of issue]**  
[from date of use]  
[NO]

'04/05/20 15:00:25

A confirmation for setting the term of validity is displayed.

[from date of issue] [from date of use] and [NO] can be switched using **F3** and **F4**.

Use **OK** to confirm the selection.

Input term of validity

[ \_months]

'04/05/20 15:00:25

To set the valid date, set the term.

Use the tenkey to a value between 1 and 99, and press **OK**.

**i** If [NO] is selected on the previous screen, the setting screen is not displayed.

Issue system setting card?

**[YES]**  
[NO]

'04/05/20 15:00:25

A confirmation for issuing a system setting card is displayed?

Select **OK** for [YES] and **CLR** for [NO].

[YES] and [NO] can be switched using **F3** and **F4**. Use **OK** to confirm the selection.

Insert system setting card 1

'04/05/20 15:00:25

Insert the system setting card 1.

**i** If [NO] is selected on the previous screen, the setting screen is not displayed.

## Settings and Making Setting Changes

Insert system  
setting card 1

'04/05/20 15:00:25

Insert the system setting card 2.

**i** If [NO] is selected on the previous screen, the setting screen is not displayed.

If you create a system setting card, the system settings can be automatically set by the magnetic data recorded on this system setting card when setting the system. This is a very convenient function.

### **!** Caution

When operations for setting the system are completed, all journal data, history information and backed up history information is deleted, and the system is initialized. If history information remains, load those history files directly loaded to the office PC.

### • Adjusting the display

The contrast of the display can be adjusted.

Adjust display [35]

[F3]:Light, [F4]:Dark

'04/05/20 15:00:25

① Press **F2** while the system is idling. In Function 2, use either **F3** or **F4** to select [Adjust display], and press **OK**.

② **F3** lightens the display; **F4** darkens the display. When you have your desired contrast, press **OK**.

**i** Any setting between 0 and 63 is possible.  
Values between 30 and 40 are in the standard range.

# Chapter 3 Troubleshooting and Maintenance

## Cleaning

Use the accessory cleaning fluid and cleaning card to clean the rollers inside the machine.

### • Frequency of cleaning

- To attain the best quality, it is recommended that the machine be cleaned every day. Or, clean once every 300 prints.
- If errors occur with high frequency, or if there are printing related problems, clean the machine each time these occur.
- "Information Cleaning" is displayed in the display on stand-alone mode. When this is displayed, clean the machine.

### • Cleaning procedures in terminal mode

- ① Press the [Cleaning] switch.
- ② Dampen the felt surfaces (both side) of a cleaning card with cleaning fluid.
- ③ Insert the cleaning card from the normal card insertion inlet.

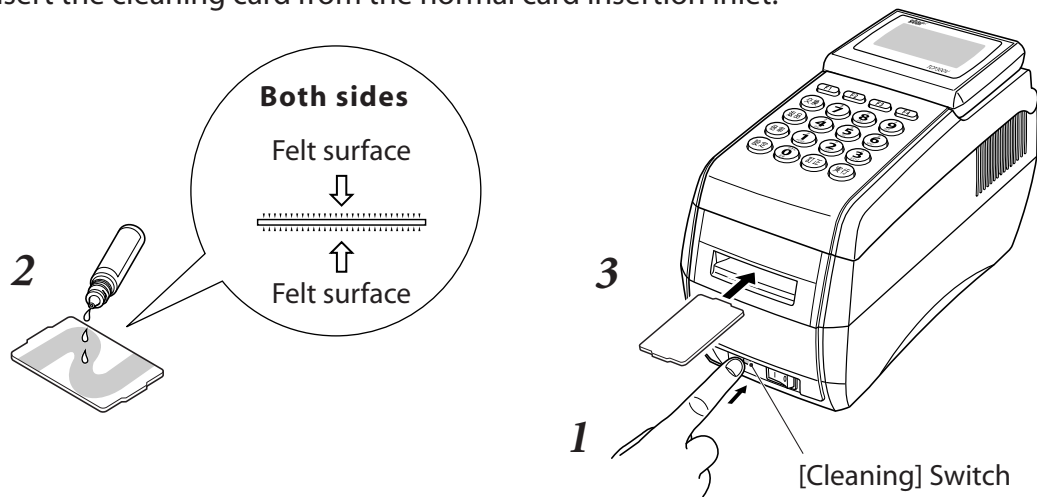

- ④ After cleaning, allow the machine to sit for approximately one minute to allow the cleaning fluid to dry.

### • Cleaning procedures in stand-alone mode

- ① Press **F2** while the system is idling.  
In Function 2, use either **F3** or **F4** to select [Cleaning], and press **OK**.

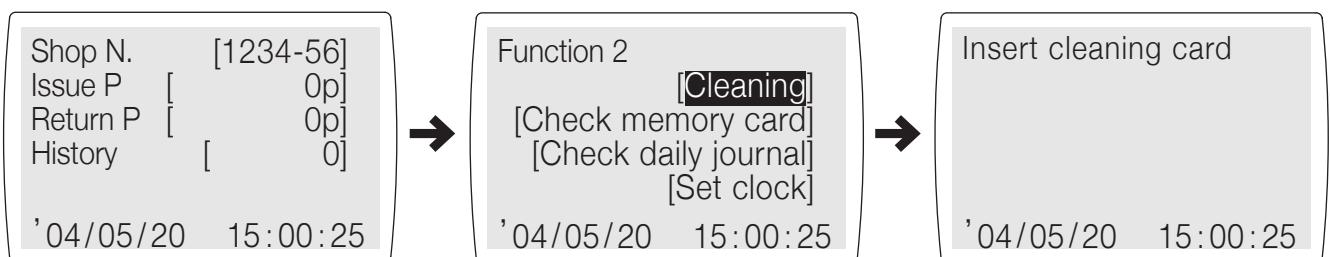

- ③ Dampen the felt surface of a cleaning card with cleaning fluid.
- ④ Insert the cleaning card from the normal card insertion inlet.

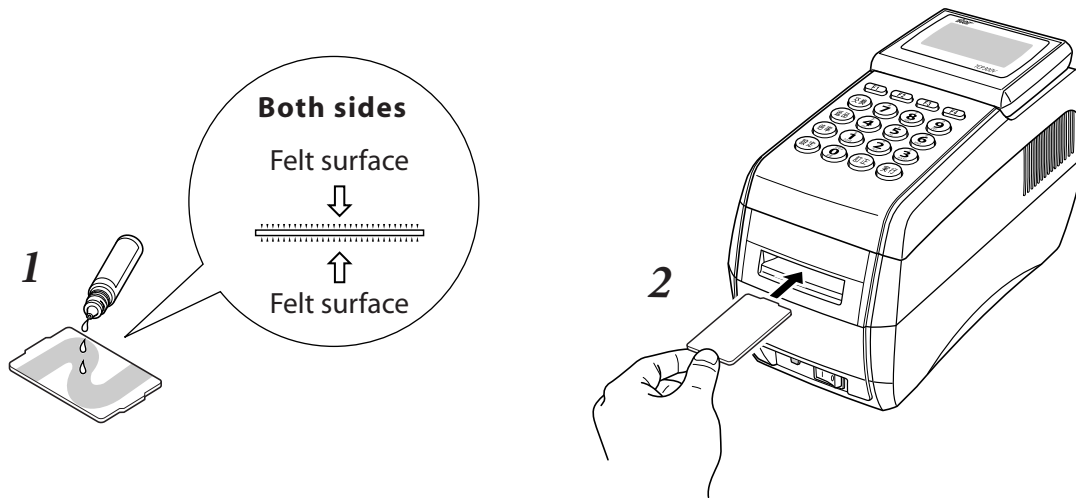

- ⑤ After cleaning, allow the machine to sit for approximately one minute to allow the cleaning fluid to dry.



### Caution

- 1** Do not use bent cleaning cards. They will jam in the machine.
- 2** Use only the accessory head cleaning fluid or dedicated head cleaning fluids for audio-video equipment. If the cleaning fluid was not included, contact your dealer.
- 3** Cleaning cards can be used approximately 30 times. If they become damaged or dirty, contact your dealer.

## When trouble occurs

### • Display message

If the following messages appear on the display during operation, check the following cause and handling procedures.

If the message continues to appear after taking measures to handle the problem, contact your dealer.

Memory card is not initialized!

'04/05/20 15:00:25

**Cause:** No memory card has been set.

**Handling:** Turn on the power to the card reader/writer while pressing the **OK** key, and set the compact flash card (system). (⇒ See page 41)

Real time clock is not set up!

'04/05/20 15:00:25

**Cause:** The real-time clock LSI is not set.

**Handling:** Turn on the power to the card reader/writer while pressing the **CLR** key, and set the time. (⇒ See page 36)

Can not correct this card!

'04/05/20 15:00:25

**Cause:** The card has already been corrected, or it is a card that was used on a different machine.

**Handling:** Only cards that have not been corrected, or machines having the same operating information of the last time, and the same shop number can make corrections. (⇒ See page 17)

This card is invalid!

'04/05/20 15:00:25

**Cause:** A card that cannot be used was inserted.

**Handling:** Check whether this is a card that can be used with this system. If it is a card that can be used with this system, check it is unusable because of scratches or bends. Issue a new card. (⇒ See page 20)

Can not record history on this card!

'04/05/20 15:00:25

**Cause:** The memory card is full of history information.

**Handling:** When transmission is valid, manually transfer the information. If transmission is not valide, use "Delete history" to erase the history information. (⇒ See page 27)

Hardware error has occurred!

'04/05/20 15:00:25

**Cause:** An error has occurred in the card reader/writer hardware.

**Handling:** Check if a card is jammed. Turn the power to the card reader/writer on again.

Card writing failed!

'04/05/20 15:00:25

**Cause:** A problem in writing to the member card occurred.

**Handling:** A problem in writing to the member card occurred because of damage or bending in the card. Issue a new card. (⇒ See page 20)

Warning !  
I-Battery Down

'04/05/20 15:00:25

**Cause:** The built-in battery on the card reader/writer is low.

**Handling:** Ask your dealer to replace the built-in battery.

System Error !  
[0000]

'04/05/20 15:00:25

**Cause:** An internal error has occurred.

**Handling:** Recheck if there is a problem in the operating environment. **Turn the power to the card reader/writer on again after reading "Precautions for Safety" in the separate manual "User's Manual."**

System Error !  
[0001]

'04/05/20 15:00:25

**Cause:** A communication error has occurred with the card reader/writer.

**Handling:** Check the cable. Turn the power to the card reader/writer on again.

## When trouble occurs

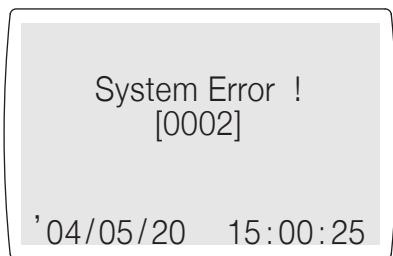

**Cause:** A compact flash memory card internal error has occurred.

**Handling:** Check whether the compact flash card is correctly installed. (⇒ See page 6) Turn the power to the card reader/writer on again.

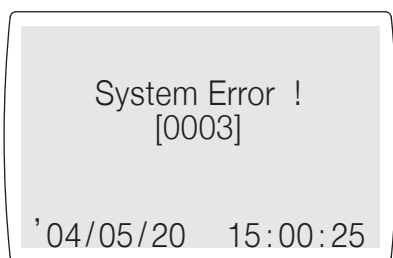

**Cause:** A compact flash memory card eject error has occurred.

**Handling:** Check whether the compact flash card is correctly installed. (⇒ See page 6) Turn the power to the card reader/writer on again.

### • Trouble when turning on the power

Symptom		Possible Cause	Handling
Power won't come on		The power plug is not correctly connected.	Correct connect the power plug.
		Short in power cord.	Contact your dealer.
		Short in power fuse.	
Power comes on and display is normal	Won't accept cards.	The printer is experiencing an error.	
	Accepts cards but reader/writer is not operating correctly.	Bad Card • Card is damaged or bent. • Card data is erased. • Other user card	Use a normal card. (If card is damaged or bent, replace the card or issue a new one. (⇒ See pages 20 and 22.))
		Head is dirty.	Clean it. (⇒ See page 54)
		The system is experiencing an error. The printer is experiencing an error.	Contact your dealer.
Power comes on and nothing is displayed.	Accepts cards.	Display lamp is expired.	

### • Trouble when operating

Symptom	Possible Cause	Handling
Reading/writing errors	Using the appropriate card type.	Use our specified card.
	Using other user card.	Use the correct card.
	Card data erased by magnet.	Replace the card, or reissue a new one. (⇒ See pages 20 and 22)
	Card is damaged or bent.	
	Head is dirty.	Clean it. (⇒ See page 54)
Card is not ejected.	Card is jammed.	Turn on the power to reader/writer again. If the card still will not eject, use the following procedures to <b>Remove the jammed cards.</b>

### Removing jammed cards

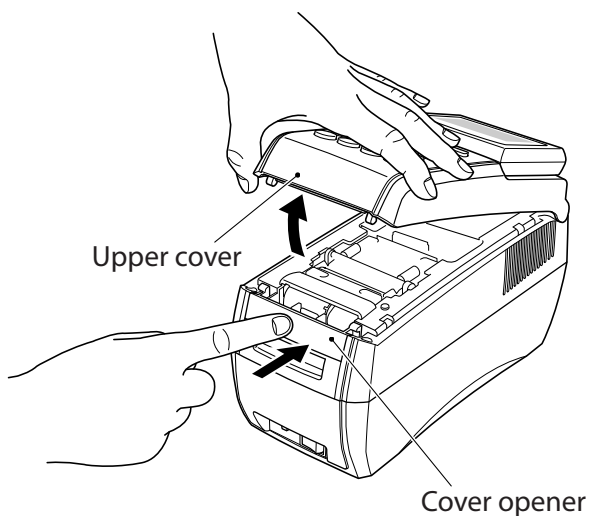

① Turn off the power and unplug the machine.

② Press the cover opener.

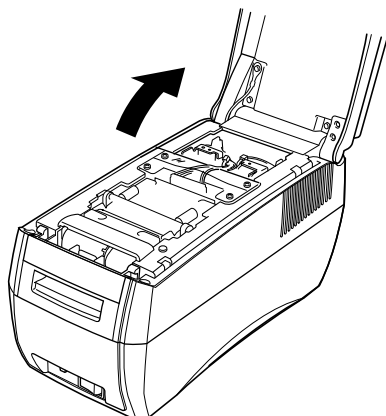

③ While pressing the cover opener, lift the upper cover. Lift the upper cover gently until it stops.



## When trouble occurs

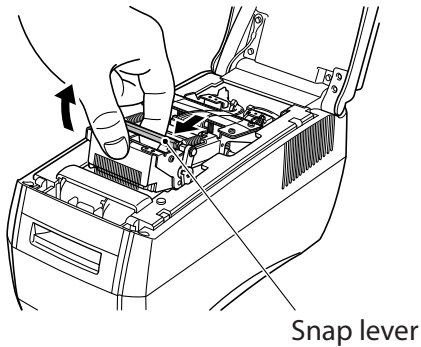

④ While pulling the snap lever (green) on the mechanism toward the front, lift the mechanism upward.

⑤ While the mechanism is completely opened, remove the jammed card.



### Caution

Do not touch the thermal head or erasing head. There is the danger of getting burned.

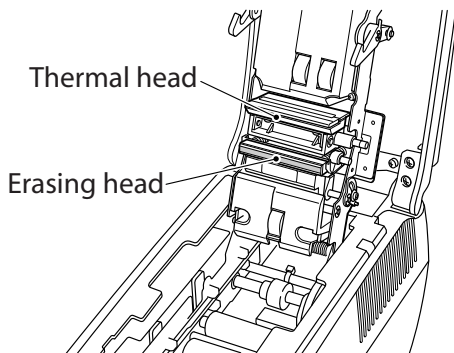

⑥ Return the mechanism to its original position and close the upper cover.



### Caution

When opening and closing the upper cover, be careful not to get your fingers or hands caught inside.

When the upper cover is open, do not allow foreign objects to fall inside.

Foreign objects can cause the system to become damaged.



**Electronic Devices Division**

536 Nanatsushinya, Shimizu-ku, Shizuoka 424-0066, Japan

Tel:0543-47-0122

*<http://www.star-m.jp/dl/dl03.htm>*